

Operation Manual

V1.0

SMARTREADER™ MULTIMODE



This Product is for Research Use Only



Thank you for purchasing the SmartReader™ MultiMode. This user manual details the instrument's features, specifications, as well as complete operating instructions; please read it carefully before operation. Keep this user manual for later use.

Important:

Please keep the box and packaging material for this instrument. If service is required, the box will be needed to ship the instrument to our Service Department.

Initial Inspection

Please inspect the instrument as well as all included accessories when you first open the packaging. If you find anything damaged or missing, please contact Benchmark Scientific or your local distributor immediately.

BENCHMARK SCIENTIFIC / ACCURIS INSTRUMENTS

PO Box 709

Edison, NJ 08818

USA

Phone: 908-769-5555

Website: www.benchmarkscientific.com / www accuris-usa.com

Email: info@benchmarkscientific.com / info@accuris-usa.com

Safety Warnings and Guidelines

1. Important information for safe use

Users should understand how to use this instrument before operating. Please read this manual carefully prior to operation.



Any improper operation may cause injury. Please read this manual carefully and operate safely according to the guidelines.

2. Operation and Maintenance

The operation and maintenance of the instrument should comply with the basic guidelines and warnings below. Incorrect operation or maintenance will have detrimental effects on the life, performance, and safety features of the instrument.



The instrument is a normal indoor instrument which conforms to class I of the GB 4793.1 standard.



This instrument is designed for use in a laboratory environment. The device must be operated by skilled laboratory personnel with appropriate training.



To prevent injury or voiding the warranty, the operator should not attempt to repair the instrument without explicit guidance from Accuris Instruments. If service is required, please contact Accuris Instruments or your local distributor for repair.



Before powering on, confirm that the voltage used meets the electrical requirements of the instrument as stated on the rating plate. If the electric cord is damaged, replace it with the same type of cord. Hold the socket firmly before pulling the plug from an outlet. Do not pull the electric cord.



The instrument should be installed in an environment of standard room temperature, low dust, low humidity, and away from direct sunlight, electromagnetic interference, and heat sources. Do not block the vents on the instrument.



Always power off the instrument when you are finished using it. Unplug the power cord and cover the instrument with a cloth or plastic sheet to prevent excessive dust from entering the housing.



Pull the connector plug from the electrical outlet immediately and contact the vendor in the event of:

- Liquid entering the housing.
- Abnormal operation: such as any abnormal sound or smell.
- The instrument is dropped or there is any damage to the housing.
- Any malfunction.

3. Maintenance

The instrument should be kept in a dry environment away from electromagnetic interference.

4. Transportation and storage requirements

Ambient temperature: 10°C ~ 35°C

Relative humidity: ≤ 80%

Atmosphere pressure range: 500 ~ 1060hpa

Place in a well-ventilated room, away from corrosive gas.

Table of Contents

Chapter 1 Introduction	1
1. Key Features	1
Chapter 2 Specifications	2
1. Required Installation Environment.....	2
2. Specifications	2
Chapter 3 Instrument Overview	4
1. Structure.....	4
Chapter 4 Instrument Setup	6
1. Preparation Before Use	6
Chapter 5 Programming & Operation	7
1. Instrument Startup.....	7
2. Quick Start Interface.....	9
3. Step Settings Interface	19
4. Analysis Interface.....	26
5. SmartDrop™ Accessory Plate	37
6. Data & Report Exporting.....	44
Chapter 6 Troubleshooting	45

Chapter 1 Introduction

The SmartReader™ Multimode is a multi-detection instrument capable of performing absorbance, fluorescence, and luminescence-based readings. Equipped with a 10-inch color touch screen, programming and operation is performed on-board. The built-in software allows for multiple algorithmic analyses of standard curves, qualitative & quantitative measurements, kinetics, spectroscopy, etc. An optional security software (FDA 21 CFR Part 11) is available for this instrument that allows for remote programming/operation via a PC.

1.1 Key Features

- The instrument has a 10-inch color touch screen with built-in processing to allow for on-board programming/operation. No PC connection is required.
- The instrument has plate shaking capabilities (linear & orbital) and an integrated incubator for accurate and uniform temperature control up to 45°C.
- The instrument is equipped to perform the following detection methods:
 - Absorbance (ABS)
 - Fluorescence Intensity (FI)
 - Fluorescence Resonance Energy Transfer (FRET)
 - Luminescence
- Depending on the detection method, the instrument selects the measurement wavelength by using either filters or a monochromator.
 - ABS measurements utilize a monochromator.
 - FI / FRET measurements utilize filters.
 - Most luminescence-based measurements do not require wavelength selection; however, a luminescence filter is included to eliminate background noise during measurements.
- The following accessories are available for this instrument:
 - Automatic Injection Module (up to two) for automatic reagent addition.
 - SmartDrop™ Accessory Plate for microvolume analyses of nucleic acids and proteins.
 - 21 CFR Part 11 compliant PC software

Chapter 2 Specifications

2.1 Required Installation Environment

Environmental temperature: 10 - 40°C

Relative humidity: ≤ 80 %

Input voltage: AC 100 – 240 V, 50 - 60 Hz, 2A

2.2 Specifications

Name	SmartReader™ Multi-Mode (MR9620)
Measurement Technologies	Absorbance, Fluorescence (FI, FRETf), Luminescence (Glow, Flash)
Absorbance	
Plate Formats	6, 12, 24, 48, 96 & 384-well microplates
Light Source	Xenon Flash Lamp
Wavelength Range	200 – 1000 nm (1 nm steps)
Wavelength Accuracy	± 2 nm
Wavelength Repeatability (SD)	0.2 nm
Bandwidth (FWHM)	< 2.5 nm
Measuring Range	0 - 4.0 OD
Resolution	0.0001 OD
Accuracy @ 450nm	± (1.0 % + 0.003) @ (0.0 - 2.0] ± 2.0 % @ (2.0 - 3.0]
Repeatability @ 450nm	CV <1.0% or SD <0.003 Fast mode (0.0 - 3.0] CV <0.5% or SD <0.003 Precise mode (0.0 - 3.0]
Stability @ 450nm	< 0.005 Abs (0.0 - 2.0 Abs] < 2% (2.0 - 3.0 Abs]
Linearity @ 450nm	R ² ≥ 0.999 [0.0 - 3.0 Abs]
Stray Light	0.1 % @ 220 nm
Reading Time	96 well: Fast mode: < 15 s; Precise Mode < 28 s
Fluorescence	
Plate Formats	6, 12, 24, 48, 96 & 384-well microplates
Reading Mode	Top reading
Excitation Light Source	Xenon Flash Lamp
Detector	PMT
Wavelength Range	Excitation: 200 - 1000 nm Emission: 270 - 850 nm
Filter EX / EM	Included: 470/525 nm, 523/564 nm, 624/692 nm
Detection Limit	≤ 1 pM
Linear Dynamic Range	6 logs

Luminescence	
Plate Formats	6, 12, 24, 48, 96 & 384-well microplates
Detector	PMT
Detection Limit	100 amol / well
Linear Dynamic Range	6 logs
Crosstalk	≤ 0.005%
Shaking & Incubation	
Shaking Mode	Linear (4.3 Hz, 7.0 Hz, & 13.5 Hz) Orbital (180 RPM, 240 RPM, & 300 RPM) Double Orbital (90 RPM, 120 RPM, & 150 RPM)
Shaking Frequency	Low, medium, high
Incubation Temperature	RT+ 4°C – 45°C
Temperature Uniformity	± 0.5°C @ 37°C
Firmware	
Display	10-inch LCD display
Operation	Touch screen; mouse
Data Capacity	10GB
Automatic Injection Module (AIM)	
Plate Formats	96–well microplates
Capacity	Up to two
Dispensing Volume	5 – 1000 µL, 1 µL increment
Liquid Injection Speed	125-500 µL / s
Accuracy	± 1 µL @ 5 - 50µL ± 2 % @ 51 - 1000µL
Waste Liquid Collection	50 mL
General Specifications	
Communication Ports	2 USB A type ports 1 USB B type port 1 Ethernet port 1 RS232 interface (AIM connection)
Size(WxDxH) cm	42.0 × 55.0 × 38.6 cm / 16.5 x 21.7 x 15.2 in.
Power Supply	AC 100 to 240 V, 50 to 60 Hz
Power	100-240 V, 2 A
Weight	33 kg / 72.8 lbs.

Chapter 3 Instrument Overview

3.1 Structure

Front

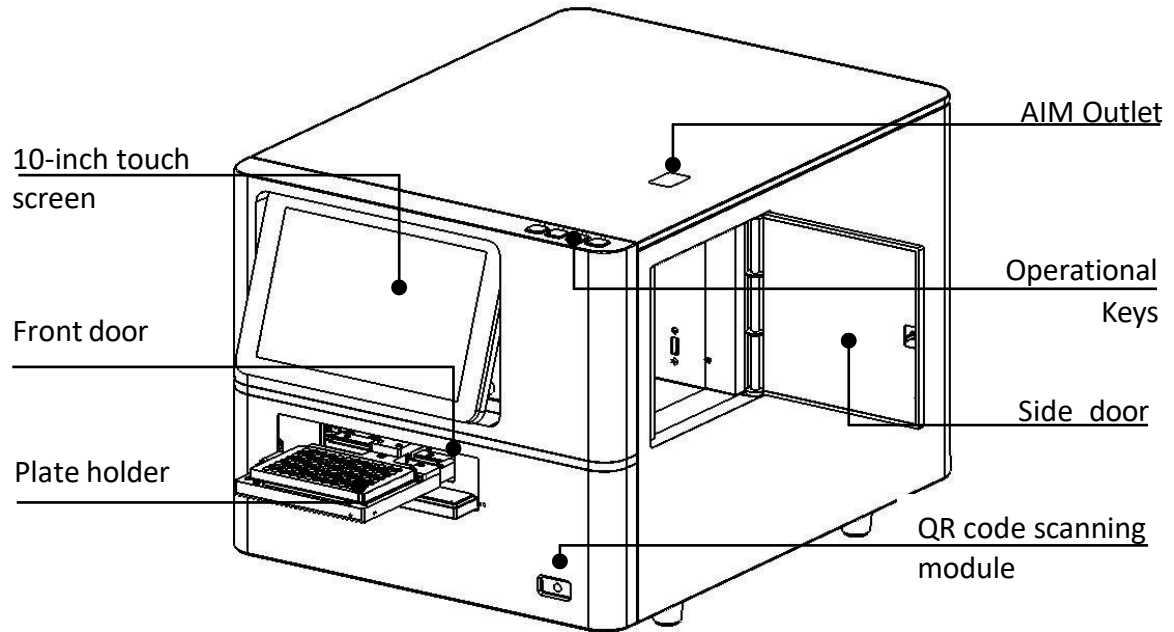

Figure 3.1.01 Front View

Side Door

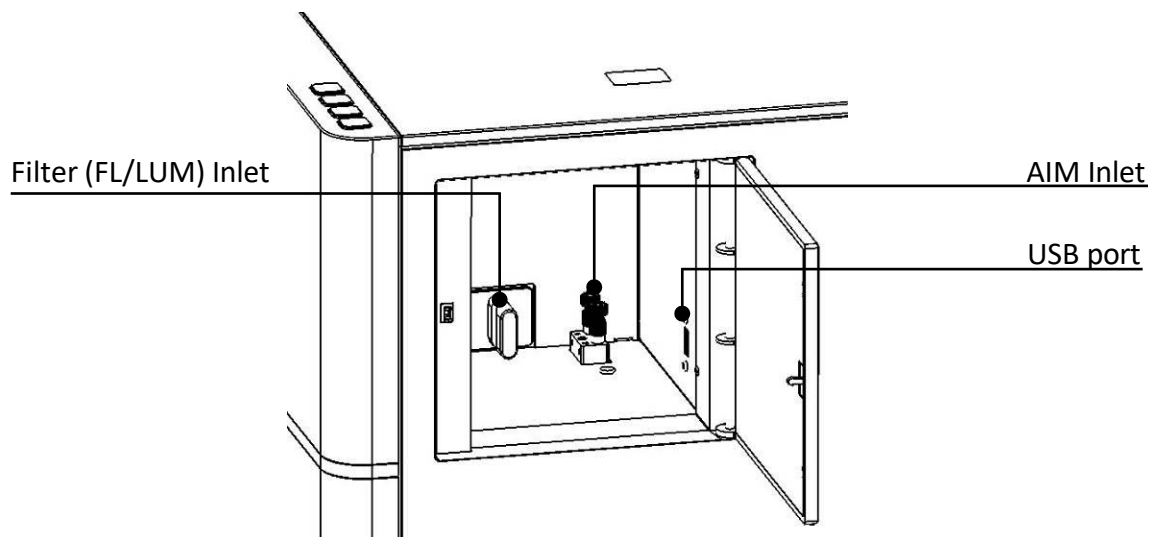

Figure 3.1.02 Side Door View

Back

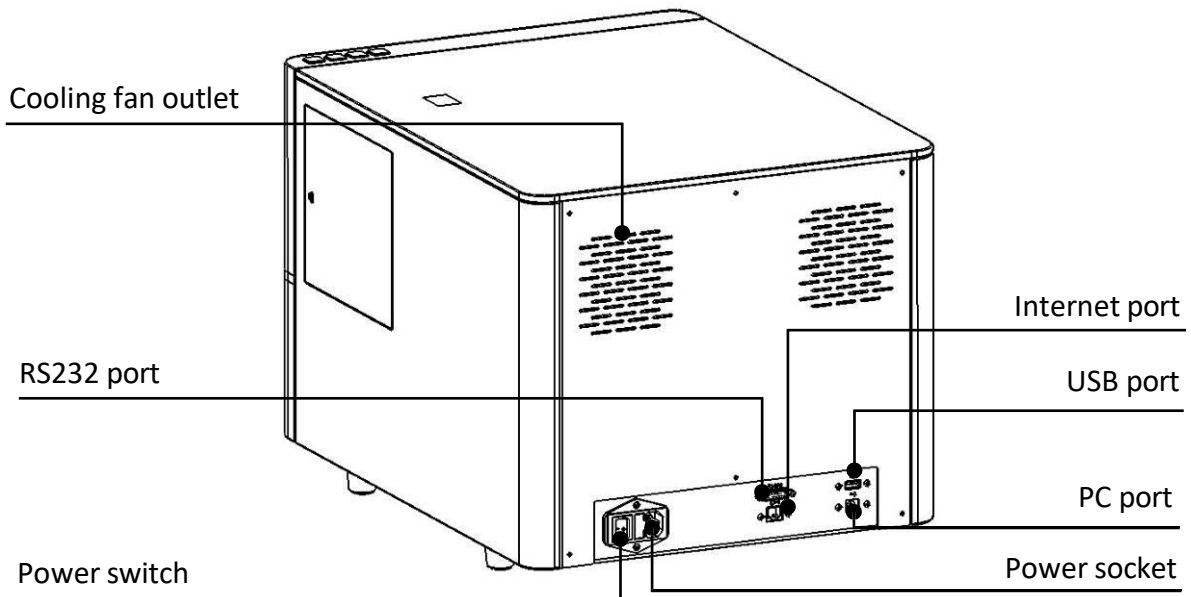

Figure 3.1.03 Back View

Figure 3.1.04; Prior to inserting the filter cartridge, the QR code (found on the filter cartridge) must be scanned by the QR code scanning module. The filter cartridge should enter smoothly if inserted in the correct orientation.

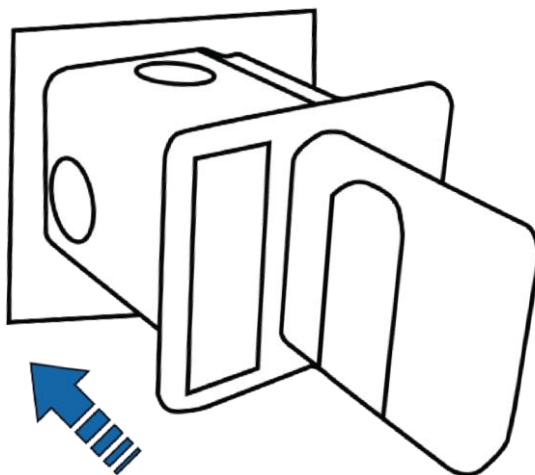

Figure 3.1.04 Filter Cartridge Insertion

Chapter 4 Instrument Setup

4.1 Preparation Before Use

IMPORTANT: This instrument weighs 33 kg (72.8 lbs.) and requires two persons to lift.

Remove the instrument from the shipping box. Place the instrument on a flat surface. Open the side door; press the button on the head of the locking pin and pull up to release the pin.

Note: The locking pin ensures that the microplate motor stays secure during transport. Please pull out the locking pin before use.

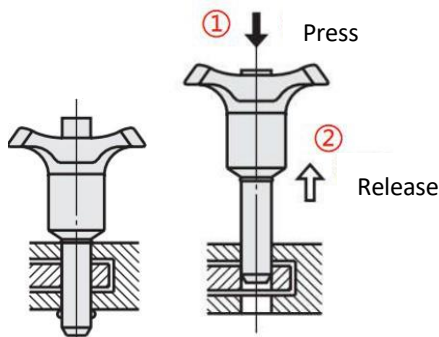

Figure 4.1.01

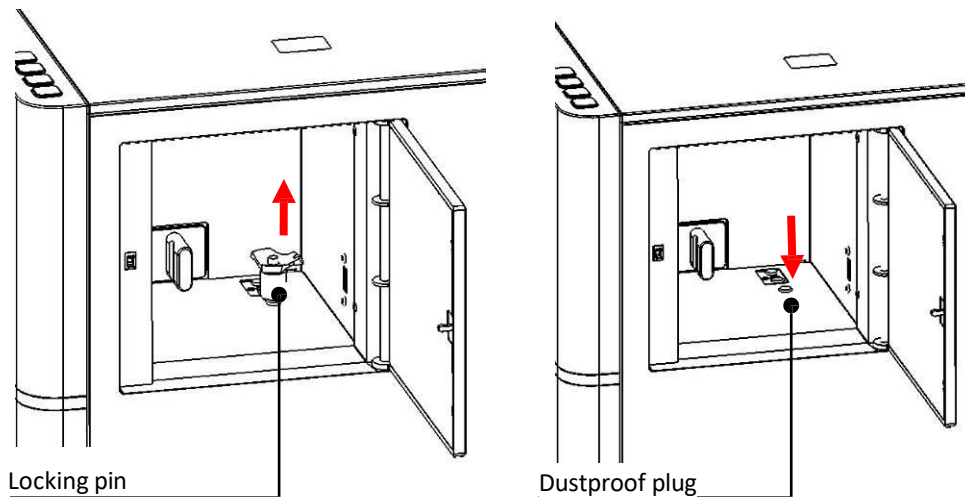

Figure 4.1.02

Chapter 5 Programming & Operation

5.1 Instrument Startup

Power the instrument on. Upon start-up, the instrument will perform an automatic calibration and self-check (**Fig. 5.1.01**).



Figure 5.1.01 Self Check Upon Startup

After calibration/self-check, the login screen will be displayed (**Fig. 5.1.02**).

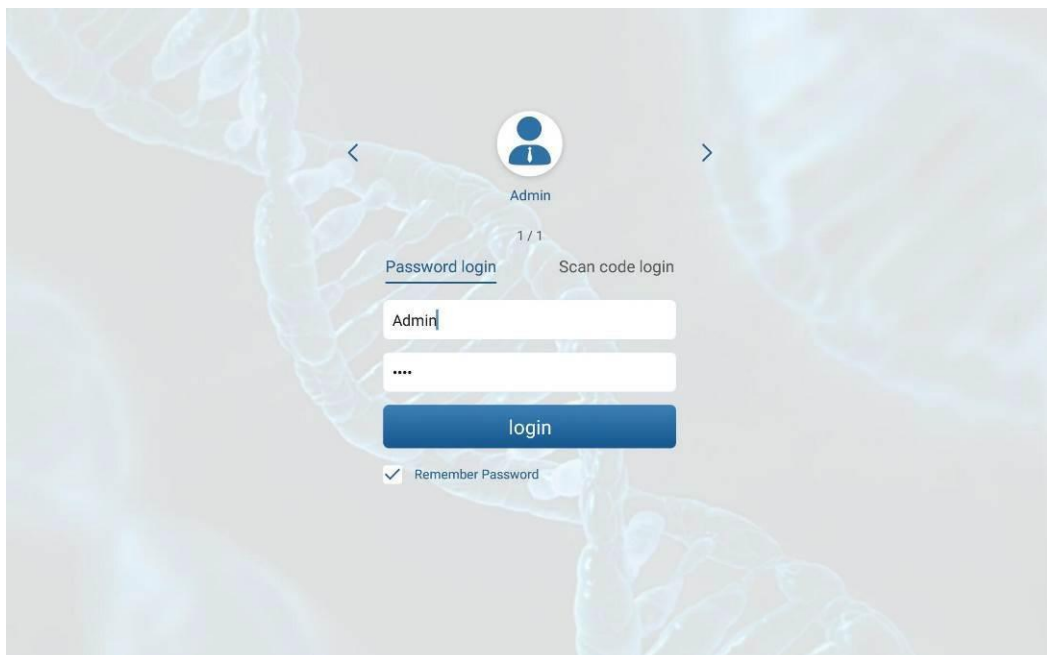

Figure 5.1.02 Login Interface

Table 5 - 1 User Permissions

Admin	Administrator account: can view & edit user permissions, generate system-wide logs, & add/delete users.	Initial password: "0000"
User	Can only perform operative functions.	

Note: Please store the set Admin password in a safe place. Contact Accuris Instruments if the admin password has been lost.

Select "Account" to enter the Account-Admin interface (Fig. 5.1.03). To make user-specific password changes, enter the "Password" tab (Fig. 5.1.04).

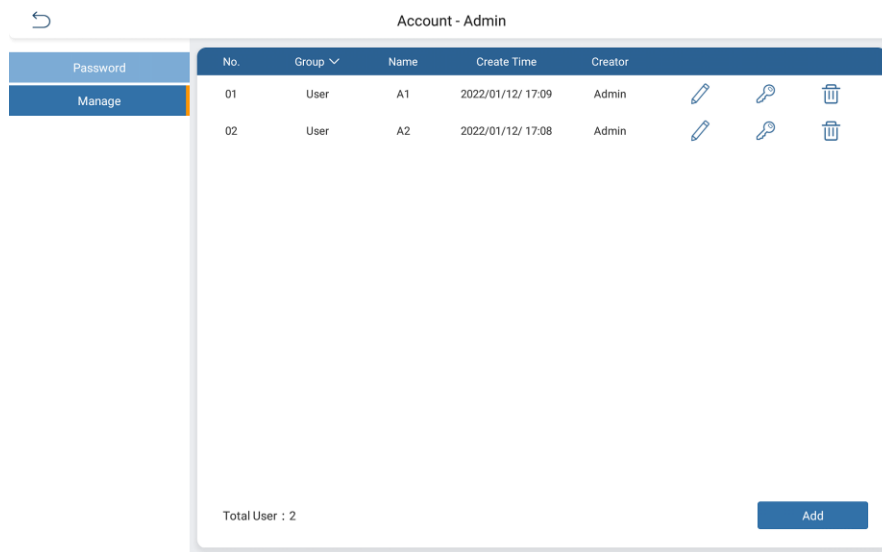

Figure 5.01.03 Account-Admin Interface

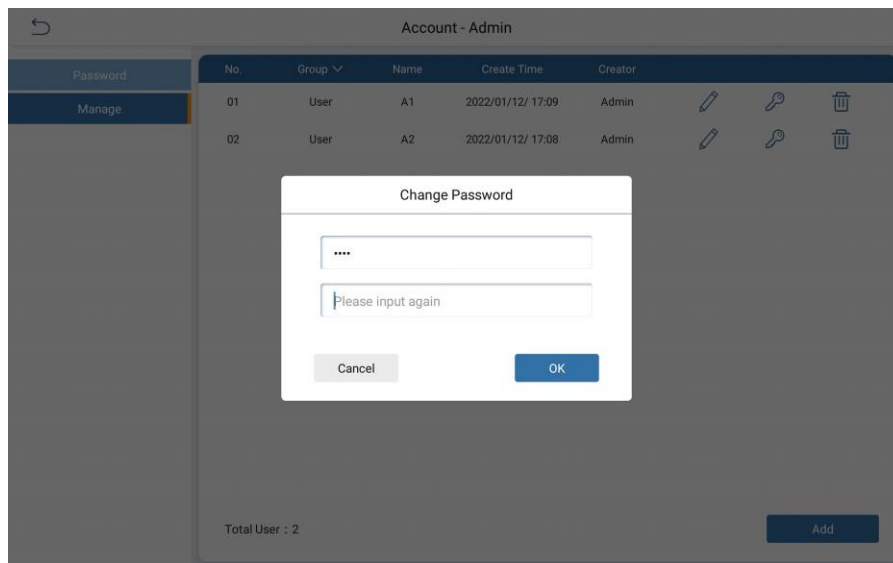

Figure 5.1.04 Change Account Password

After entering the user-specific password, the Main Menu Interface is displayed (Fig. 5.1.05)

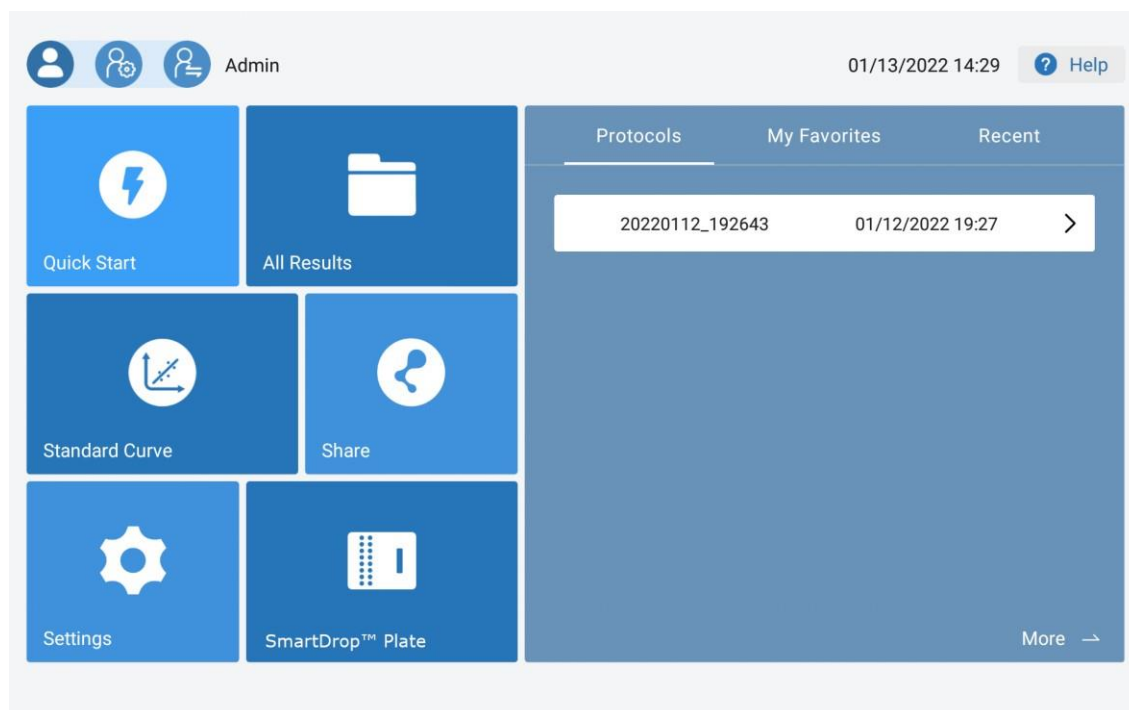

Figure 5.1.05 Main Menu Interface

Table 5 - 2 Main Menu Interface Operations

Name	Function
Quick Start	Select to create a new protocol.
All results	Select to view a list of all previously saved protocol results.
Standard curve	Select to view the standard curve library
Share	Select to view a list of executed protocols, standard curves, etc., for transfer (USB, FTP, etc.)
Settings	Select to enter the settings interface
SmartDrop™ Accessory Plate	Select to enter the SmartDrop Accessory Plate Interface. This interface allows for microvolume analyses of Nucleic Acids & Proteins using the SmartDrop Accessory Plate (not included).
Protocol	Select to view a list of protocols saved to this shortcut.
My favorites	Select to view a list of favorite protocols.
Recent	Select to view a list of the most recent protocols created/run

5.2 Quick Start Interface

Select "Quick Start" on the main interface to enter the Quick Start interface. Users can select protocol parameters according to experimental requirements (**Fig. 5.2.01**).

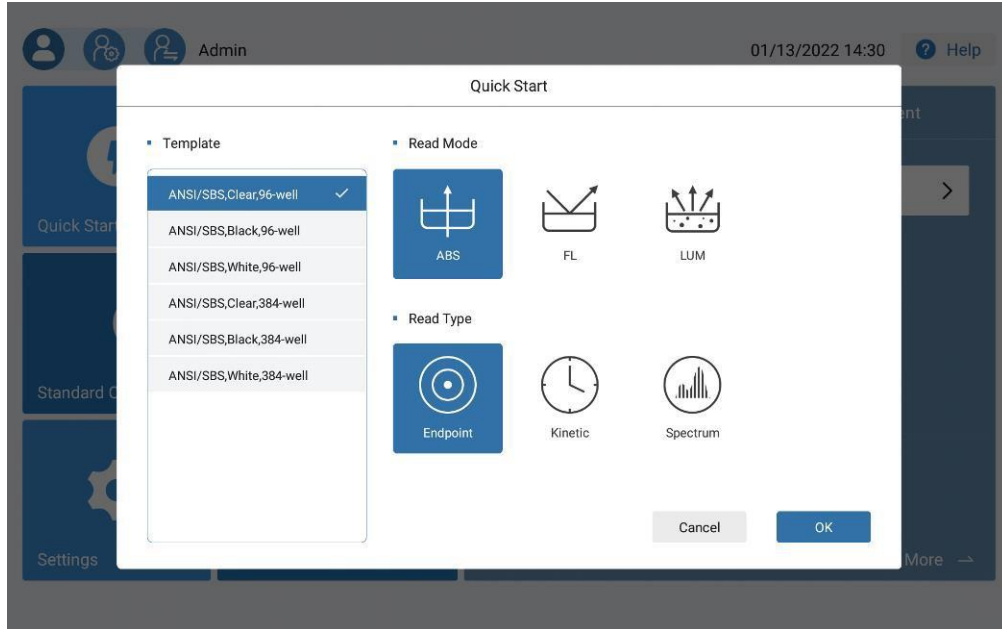

Figure 5.2.01 Quick Start Interface

There are three read modes: ABS, FL, LUM. The ABS mode has three reading types: EndPoint, Kinetic, & Spectrum. FL & LUM only have two read types: EndPoint and Kinetic. The EndPoint method only takes one reading at the end of a protocol, whereas the Kinetic method performs readings during selected intervals, with a minimum of two reads and a maximum of 99. The Spectrum method performs readings within the designated wavelength range.

Table 5 - 3 Functions Available For ABS, FL, & LUM Readings

	Endpoint	Kinetic	Spectrum
ABS	1.General 2.Shake 3.Advanced 4.Area Selection	1.General 2.Detection 3.Shake 4.Advanced 5.Area Selection	1.General 2.Shake 3.Advanced 4.Area Selection
FL			
LUM	1.Injector 2.General 3.Shake 4.Advanced 5.Area Selection	1.Injector 2.General 3.Detection 4.Shake 5.Advanced 6.Area Selection	

The instrument can accept 6, 12, 24, 48, 96, & 384 well microplates. Table 5 - 4 lists the types of compatible 96 & 384-well microplates for use with the instrument.

Table 5 – 4 Compatible 96/384-well Plate Types

Well plate	Name
96 well plate	ANSI/SBS,clear,96-well
	ANSI/SBS,black,96-well
	ANSI/SBS,white,96-well
384 well plate	ANSI/SBS,clear,384-well
	ANSI/SBS,black,384-well
	ANSI/SBS,white,384-well

After selecting protocol parameters, select "OK" to enter the main protocol interface (**Fig. 5.2.02**). It consists of title bar, main display area, menu bar and settings bar.



Figure 5.2.02 Main Protocol Interface

5.2.01 Title Bar

The title bar can be used to return to the previous page, perform protocol operations, name, and modify files (**Fig 5.21.01**).

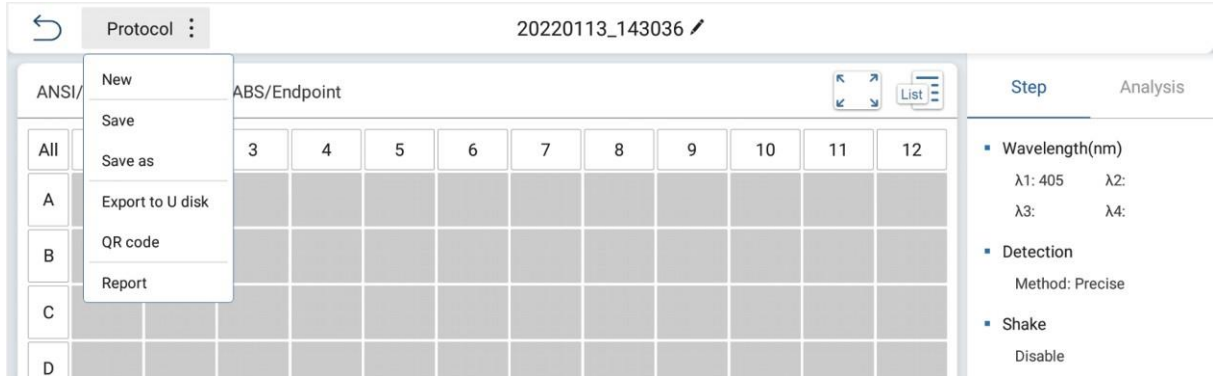

Figure 5.21.01 Title Bar

Table 5 - 5 Legend: Title Bar Operations

Name	Functions
	Return to the main menu. Click and a prompt box will pop up asking the user to exit the current interface; click "OK" and another prompt box will pop up "Do you want to save the current protocol?"; click "OK" to save and exit; click "No" to exit without saving.
	Name/Rename the current file. Click to display the input box to modify the current name.
Protocol	Click to display operation options, including New, Save, Save as, Export to U disk, scan QR code.
New	Click and the selection box (Fig. 5.21.02) will be displayed.
Save	Save the current file/results.
Save as	Save the protocol under a different name.
Export to U disk	Export file to a USB drive (USB drive must be inserted into instrument prior to performing this operation).
QR code	Generate a QR code for the data on the left of the standard curve.

Click the "", and the input box for modifying the protocol name will pop up, (**Fig. 5.21.02**). The red text indicates that the new protocol name has already been used once before.

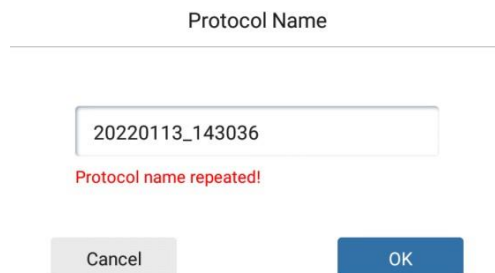

Figure 5.21.02 Create a New Protocol

5.2.02 Main Display Area

The default plate layout is set to a 96-well microplate format, consisting of 8 rows (A-H) & 12 columns (1-12). Click A-H to select all the wells in the row; click 1-12 to select all the wells in this column. Select “All” above row label “A” to select all the wells of the plate.

In the Settings Bar, users can view Kinetic or Spectrum analyses. According to the set reading type (Endpoint, Kinetic, Spectrum), the contents of the main display area vary. **Fig. 5.22.01** shows the results of an executed Endpoint protocol.



Figure 5.22.01 Endpoint Protocol Results

After the protocol is finished, the heat diagram is shown (**Fig. 5.22.02**).

Note: Only Endpoint protocols have heat diagrams.

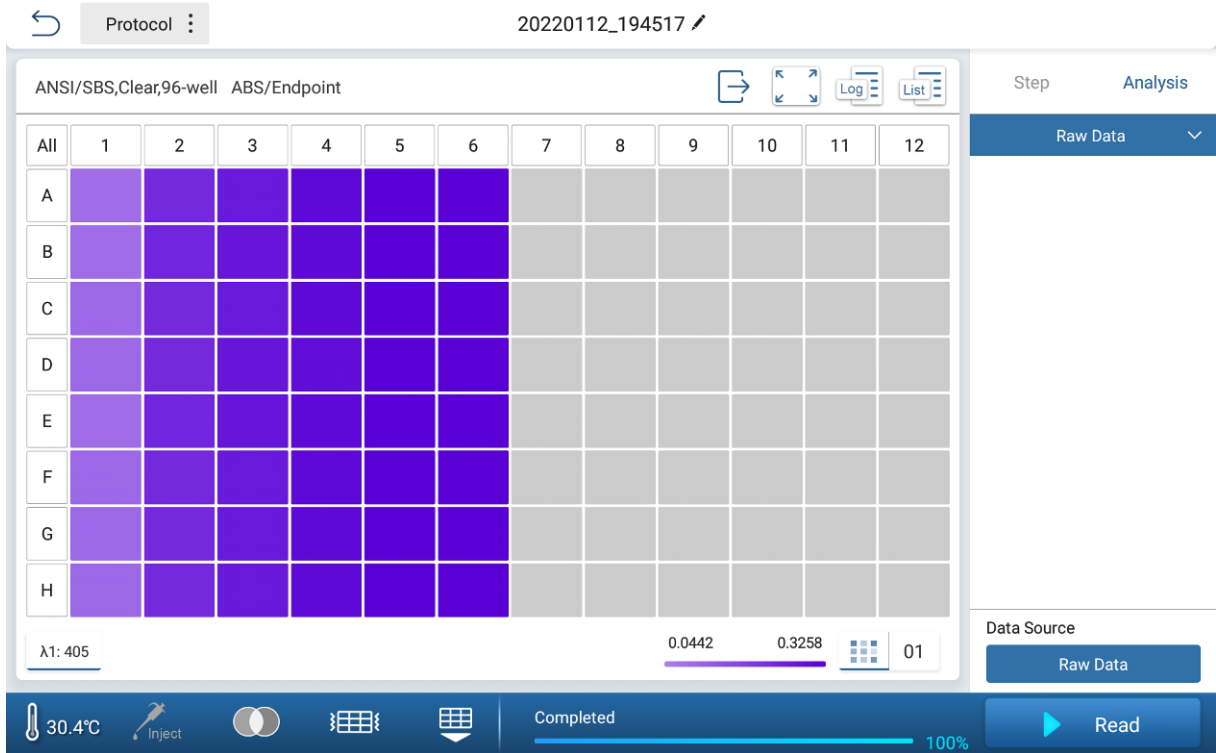

Figure 5.22.02 Heat Diagram Interface (Endpoint)

Fig. 5.22.03 shows the interface when a Kinetic protocol has finished.

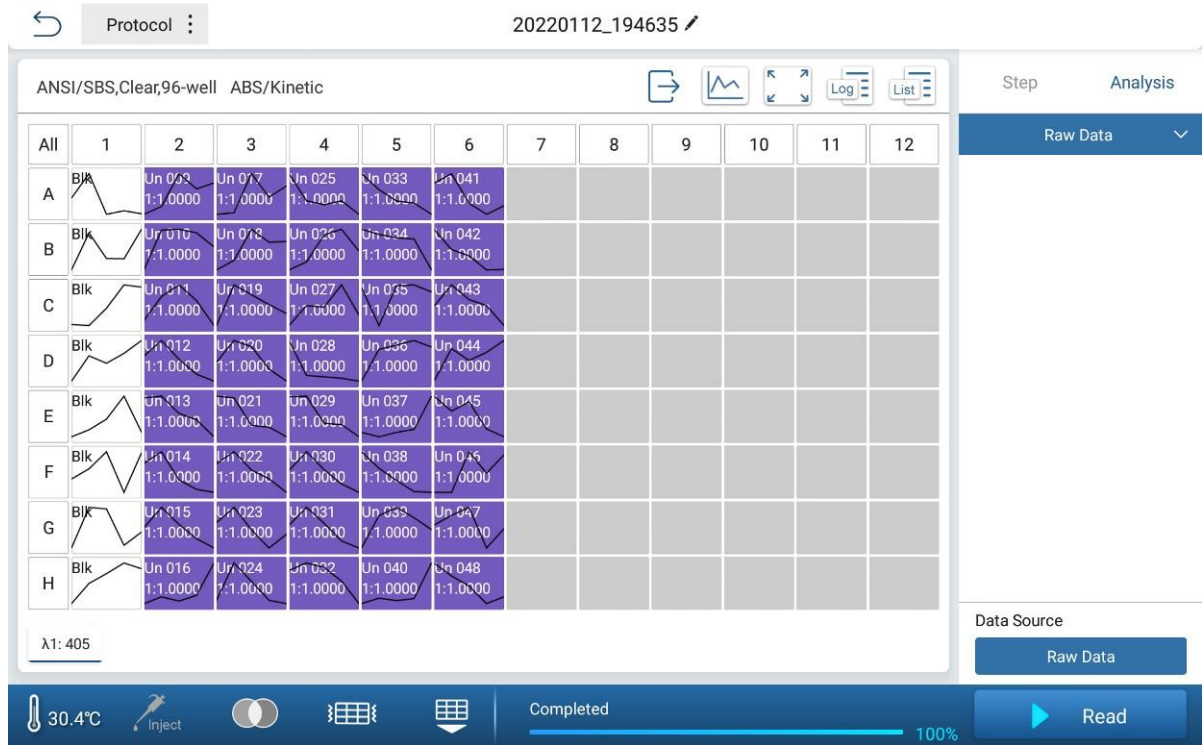

Figure 5.22.03 Kinetic Protocol Results

5.2.03 Settings Bar

In the Settings Bar, the “Step” tab can be used to view the selected wavelengths, detection methods, reading intervals, shaking levels, etc. To adjust these settings, see **Chapter 5.3.1** .

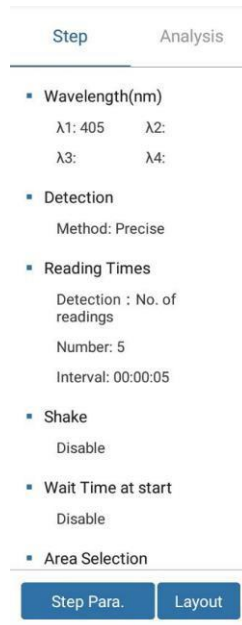

Figure 5.23.01 Settings Bar







5.2.04 Menu Bar

The lower area of the display is the menu bar (**Fig. 5.24.01**). It includes operations for incubation, injectors, filters, shaking, plate in/out, & commencing a plate reading.



Figure 5.24.01 Menu Bar

Table 5 - 4 Legend: Menu Bar Operations

Name	Definition
	Select to adjust the incubation settings
	Select to adjust the Automatic Injection Module settings
	Select to pop up the filter settings box (FL/LUM mode only)
	Select to perform quick temporal shaking (1 second)
	Select to insert/retrieve the plate holder.
	Select to start a plate read.

Incubation Settings:

Select  to enter the incubation parameters interface (**Fig. 5.24.2**). Incubation can be toggled on/off, and the temperature can be adjusted from a range of 15°C – 45°C. Once the incubation settings have been adjusted, select “OK” to save your adjusted setting, or select “Cancel” to return to the main protocol interface.

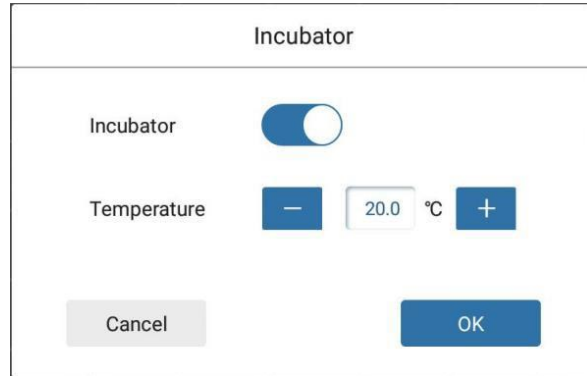



Figure 5.24.02 Incubator Settings Interface

Table 5 - 5 Legend: Incubation Settings

Name	Function
Incubator	On or off, off by default
Temperature	Input the target temperature, ranging from RT+4°C to 45°C;
OK	Click to save the current setting
Cancel	Return button

Automatic Injection Module (AIM) Settings: If the instrument does not have an automatic injection module (optional), the icon will be unavailable. When the icon is highlighted in white, select  to view and/or adjust the Injection Module parameters (**Fig. 5.24.03** and **Fig. 5.24.04**).

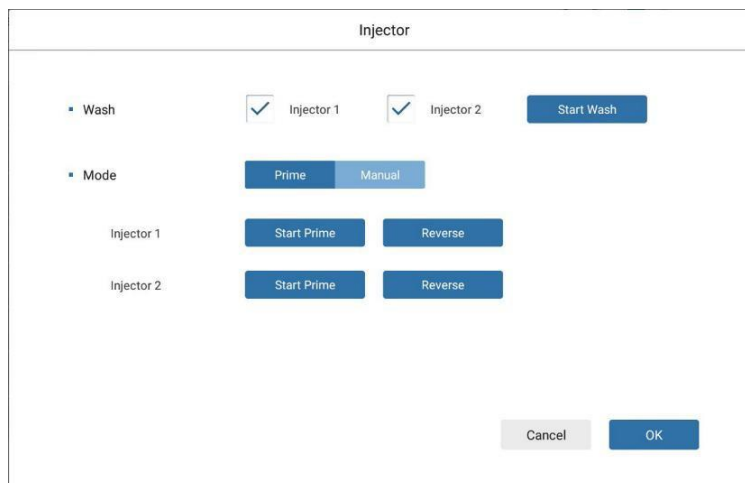

Figure 5.24.03 AIM Settings - Prime Mode

Figure 5.24.04 AIM Settings - Manual Mode

Table 5 - 6 Legend: Automatic Injection Module Operations

Name	Function
Wash	Select the injector(s) to be used in the current protocol.
Mode	Select the injector mode. The default setting is set to Prime. In Prime mode, the wash volume of is fixed. Select “Manual” to manually prime the AIM tubing.
Start Wash	Select to start reagent injection.
Start	Select to aspirate reagents from their reservoir to the corresponding injector.
Reverse	Select to move residual reagent in the tubing back into the reagent reservoir.

Filter Settings: (Fluorescence/Luminescence Only):

Select “” to enter the filter parameters interface. (Fig. 5.24.05) The interface will display the excitation / emission λ for the currently installed filter. To add a new filter, select “Replace”; the QR code scanner, found at the bottom right corner of the front of the instrument, will turn on. Scan the QR code located on the new filter to incorporate it into the system.



Figure 5.24.05 Filter Settings Interface

Table 5 - 7 Legend: Filter Settings

Name	Function
Excitation	Display the wavelength of excitation light;
Emission	Display the wavelength of emission light;
Replace	Click the instrument scanning module to scan the code. The user can scan the QR code of the new filter, and the interface will display the parameters of the new filter. Users can manually replace the filter;

5.3 Step Settings Interface

5.3.1 Step Settings Interface: Absorbance

The step settings interface for both Endpoint and Kinetic modes for absorbance are identical (**Fig 5.31.01**). Users can select up to 4 wavelengths to utilize in the readings. To input any wavelength from 200-1000 nm, select the value of the current wavelength to adjust it. λ_1 defaults to 405nm, λ_2 to 450nm, λ_3 to 492nm, and λ_4 to 630nm. Detection can be set to Precise (96 well: <26 seconds), or Fast (96 well: <15 seconds). The default detection mode is set to precise.

The screenshot shows the 'ANSI/SBS,Clear,96-well' and 'ABS/Endpoint' settings. Under 'Wavelength', there are four rows for λ_1 (405 nm, purple), λ_2 (450 nm, blue), λ_3 (492 nm, green), and λ_4 (630 nm, yellow). Each row has a checkbox and a color swatch. A numeric keypad is overlaid on the right, showing digits 1-9, 0, a decimal point, and a left arrow, with 'C' and 'OK' buttons at the bottom. Under 'Detection', there are two buttons: 'Precise' (selected) and 'Fast'.

Figure 5.31.01 Step Settings Interface (Endpoint / Kinetic): Absorbance

The step settings interface for the Spectrum mode is shown in **Fig 5.31.02**. Enter the starting wavelength and the ending wavelength (200 – 1000nm) to define the range of readings. The default starting value is set to 200nm, and the default ending value is set to 300nm. The “Step” input box allows for specifying measurement intervals (default step value is set to 10). For example: A spectrum reading range from 200nm – 400nm with a step value of 10 will conduct measurements at 200nm, 210nm, 220nm... 400nm.

The screenshot shows the 'ANSI/SBS,Clear,96-well' and 'ABS/Spectrum' settings. Under 'Wavelength', there are three input fields: 'Start' (200), 'End' (300), and 'Step' (10). Each field has a corresponding color swatch. A horizontal spectrum bar is shown to the right, with a 'Start' label above the beginning and an 'End' label above the end. Under 'Detection', there are two buttons: 'Precise' (selected) and 'Fast'.

Figure 5.31.02 Step Settings Interface (Spectrum): Absorbance

5.3.2 Step Settings Interface: Fluorescence

The general step settings interface for both Endpoint and Kinetic modes for fluorescence are identical (**Fig 5.32.01**).



Figure 5.32.01 Step Settings Interface (Endpoint / Kinetic): Fluorescence

Table 5 - 8 Legend: Step Settings (Endpoint/Kinetic): Fluorescence

Name	Function
Wavelength	Select to display the current excitation wavelength (EX) and emission wavelength (EM) of the instrument.
Detection	Select to adjust reading speeds. Select precise, normal, or fast. If precise detection is selected, the “Number” input box will appear. The “Number” indicates the # of measurements made under precise mode.
PMT Gain	Optional Automatic/Low/Medium Low/Medium High/High, default automatic. By default, when a plate read is initiated, the reader performs an automatic check to determine the optimum PMT gain setting for the wells to be measured.
Settle Time	Settle time can be entered, default 150ms, range 5-999ms.
Integration Time	Integration time can be entered, default 40us, range 5-1000us.

PMT Gain: Low signal intensities require higher gains, whereas intense signals require lower gains. By default, PMT Gain is set to “Automatic”.

Integration Time: The period of time from when the lamp flashes to excite the sample to when the detector finishes gaining the signal.

Settle Time: The period of time prior to AIM reagent addition.

5.3.3 Step Settings Interface: Luminescence

The general step settings interface of Endpoint and Kinetic modes for luminescence are identical (**Fig. 5.33.01**).

ANSI/SBS,Clear,96-well LUM/Endpoint

Step

Injector

General

Shake

Advanced

Area Selection

▪ Detection

PMT Gain Automatic ▾

Settle Time 150 ms

Delay 1 20 ms

Integration Time 1 400 ms

Delay 2 20 ms

Integration Time 2 400 ms

Figure 5.33.01 General Step Settings Interface (Endpoint / Kinetic LUM)

Delay 1 / Delay 2: The period of time from after the AIM has performed reagent addition to when measurement begins.

The automatic injection module (AIM) is limited to fluorescence and luminescence-based readings. In this interface (**Fig. 5.33.02**), users can select either/both AIM's and adjust their respective dispense volume (5-500 μ L) & speed (5-500 μ L/s) (**Fig. 5.33.02** & **Fig. 5.33.03**). The default dispense volume is set to 100 μ L, and the default speed value is set to 200 μ L/s.

ANSI/SBS,Clear,96-well LUM/Endpoint

Step

Injector

General

Shake

Advanced

Area Selection

▪ Injector

No reagent Reagent 1 Reagent 2 Both

Volume 100 μ L

Speed 200 μ L/s

Figure 5.33.02 AIM Reagent 1 Selected

ANSI/SBS,Clear,96-well LUM/Endpoint

Injector

No reagent Reagent 1 Reagent 2 Both

Volume 1 100 μL

Speed 1 200 $\mu\text{L/s}$

Volume 2 100 μL

Speed 2 200 $\mu\text{L/s}$

Step

Injector

General

Shake

Advanced

Area Selection

Figure 5.33.03 Both AIM Reagents Selected

5.3.4 Kinetic Read Settings

When a kinetic reading type is selected, enter the step settings interface, and select "Reading Times". The settings are divided into total time and number of readings, as shown in **Fig. 5.34.01** and **Fig. 5.34.02**. Users can input the total time required for a kinetic assay and input the frequency of readings, or simply input the number of readings required and the frequency of readings. **Table 5-9** lists the parameters that can be set.

ANSI/SBS,Clear,96-well ABS/Kinetic

Detection

Total Time No. of readings

Total Time (hh:mm:ss) 00 : 00 : 25

Interval (hh:mm:ss) 00 : 00 : 05

Read

Reading 1 Reading 2 Reading 3

Interval

Total Time

Figure 5.34.01 Kinetic Mode - Total Time Setting

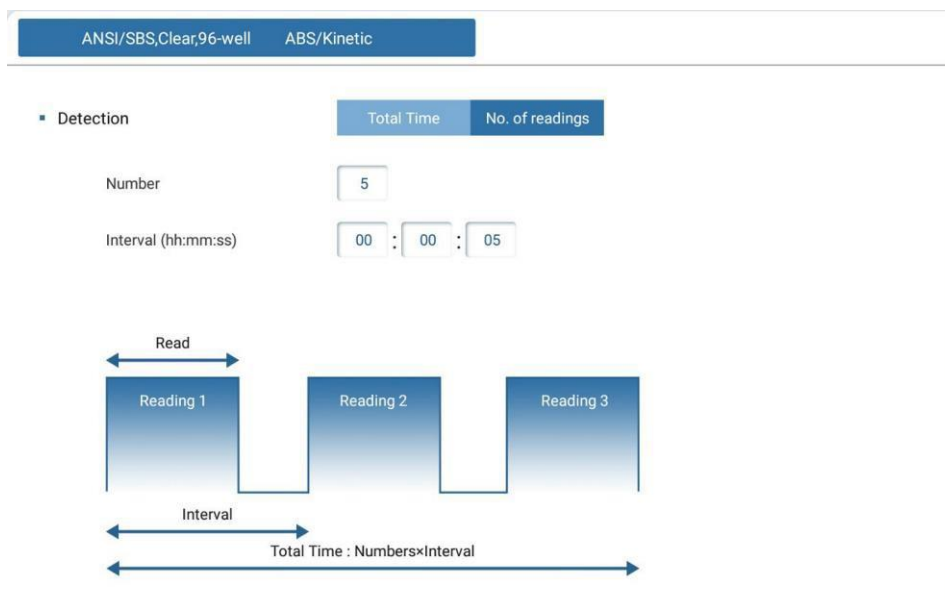

Figure 5.34.02 Kinetic Mode - No. of readings Setting

Table 5 - 9 Legend: Kinetic Read Settings

Name	Function
Total Time/No. of readings	The total time / intervals under which kinetic readings will be performed; The maximum time is 99:59:59
Number	The number of readings to be performed; The maximum number is 99
Interval	The frequency at which individual readings are performed; The maximum time is 99:59:59;

5.3.5 Shake Settings Interface

Under any reading mode (ABS, FL, or LUM), select “Shake” in the step settings interface to enter the shake settings interface (**Fig. 5.35.01**).

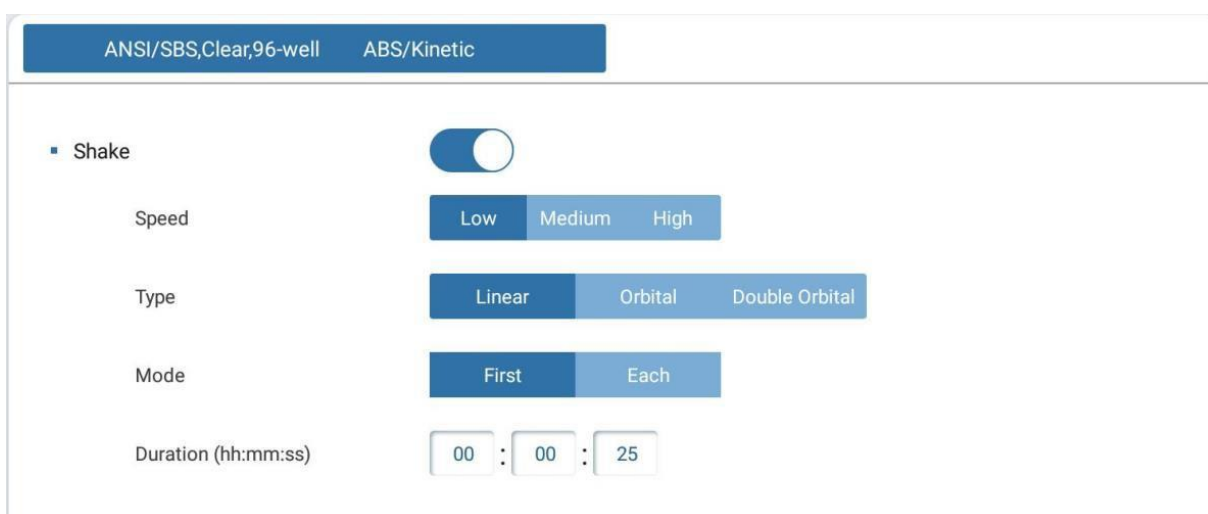

Figure 5.35.01 Shake Settings Interface

Table 5 - 10 Legend: Shake Settings

Name	Default settings
Shake	Toggle switch to enable shaking; The default value is off;
Speed	“Low”, “Medium”, & “High” shaking speed can be selected; The default value is set to “Low”.
Type	“Linear”, “Orbital”, & “Double Orbital” shaking type can be selected; The default value is set to linear.
Mode	Select when readings occur; select “First” to shake only once when the protocol begins. Select “Each” to shake prior to every plate reading (kinetic mode only); The default value is set to “First”.
Duration	Select the duration of shaking of up to 23:59:59; The default value is set to 00:00:25.
From	Select the set shaking parameters to operate based on the entire plate, or by each individual well (luminescence mode only); The default value is set to plate.

5.3.6 Advanced Settings Interface

Select “Advanced” in the general step settings interface to enter the advanced settings interface. Users can adjust settings for “Wait Time at start”: the time after a protocol has begun prior to reading the inserted plate (**Fig. 5.36.01**).



Figure 5.36.01 Advanced Settings Interface

5.3.7 Plate Layout Interface

Select the "Layout" button found at the bottom of the Settings Bar on the main display area (Fig. 5.37.01).

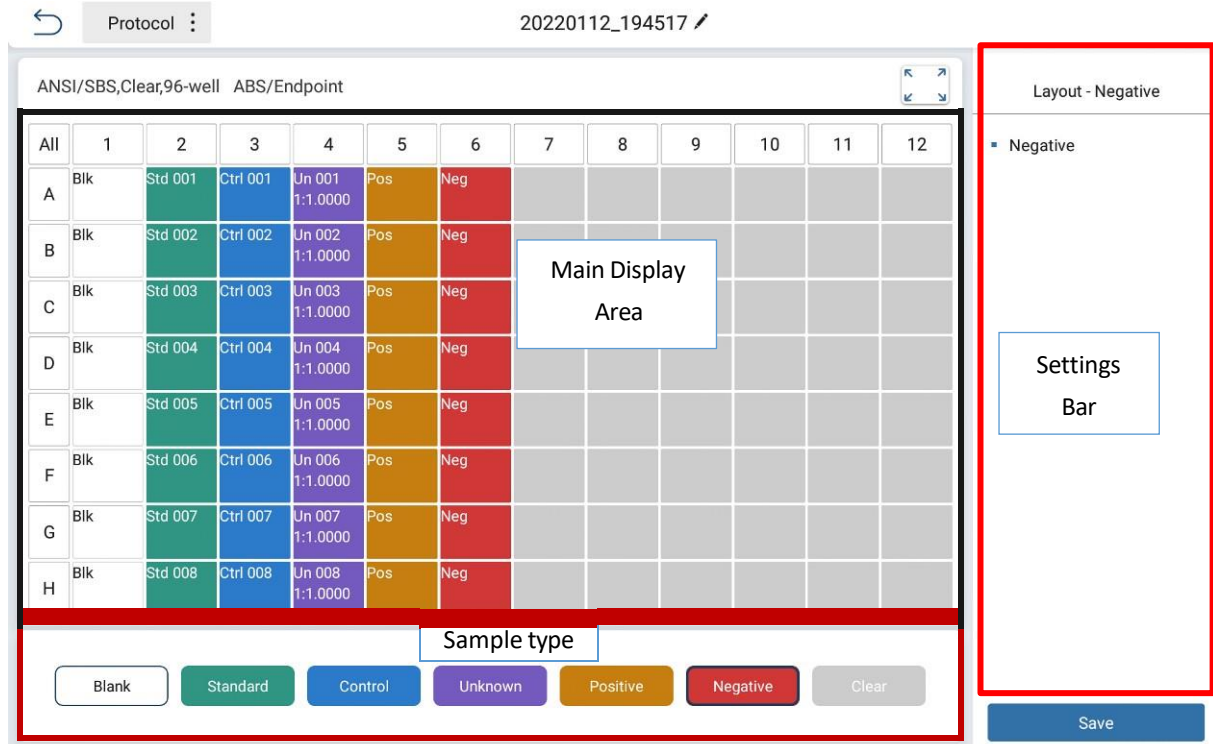

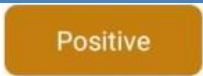



Figure 5.37.01 Plate Layout Interface

Sample types include blank, standard, quality control, unknown, negative, positive and clear.

Table 5 - 11 Legend: Available Sample Types in Plate Layout Interface

Name	Function	Icon
Blank	By default, the blank corresponds to a group name and number. The "Blank Subtraction" in can be used to calculate the average of all blank samples, and then subtract the average blank value from a selected group of unknowns, standards, etc.	
Standard	To generate a standard curve, standard samples must be included in the plate layout. Standards can be inputted as single samples, or in replicates. The concentration of the standard must be set in advance.	
Control	The Control button allows the user to input quality control samples. Quality control samples can be run in replicates.	
Unknown	The Unknown button allows the user to input sample types of unknown concentrations. Unknowns can be	

	inputted as single samples, or in replicates, with an optional dilution factor setting.	
Negative	Negative control samples are used for the correlation of unknown samples to the standard curve.	
Positive	Positive control samples are used for the correlation of unknown samples to the standard curve.	
Clear	The Clear button allows the user to unassign any sample type on the plate layout. When a new protocol is created, the default setting for all wells is set to Clear.	

5.4 Analysis Interface

Select the "Analysis" button found at the top of the settings bar to enter the analysis interface (**Fig. 5.4.01**). The main display area includes the operation bar and the display area.

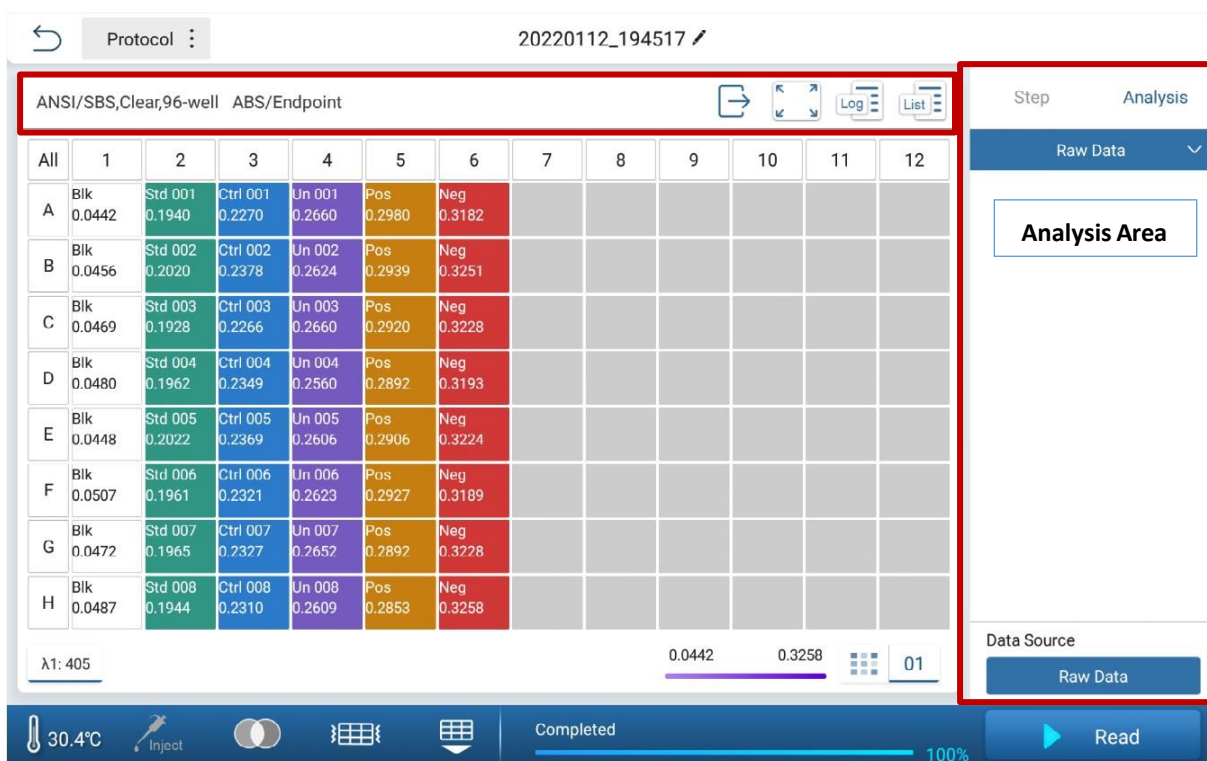

The screenshot displays the Analysis Interface for a 96-well plate. The main area shows a grid of wells with data values. The top bar includes a protocol name '20220112_194517' and a 'Protocol' dropdown. The right sidebar has a 'Step' dropdown set to 'Analysis' and a 'Raw Data' button. The bottom bar shows a temperature of 30.4°C, an 'Inject' button, and a 'Read' button.

All	1	2	3	4	5	6	7	8	9	10	11	12
A	Blk 0.0442	Std 001 0.1940	Ctrl 001 0.2270	Un 001 0.2660	Pos 0.2980	Neg 0.3182						
B	Blk 0.0456	Std 002 0.2020	Ctrl 002 0.2378	Un 002 0.2624	Pos 0.2939	Neg 0.3251						
C	Blk 0.0469	Std 003 0.1928	Ctrl 003 0.2266	Un 003 0.2660	Pos 0.2920	Neg 0.3228						
D	Blk 0.0480	Std 004 0.1962	Ctrl 004 0.2349	Un 004 0.2560	Pos 0.2892	Neg 0.3193						
E	Blk 0.0448	Std 005 0.2022	Ctrl 005 0.2369	Un 005 0.2606	Pos 0.2906	Neg 0.3224						
F	Blk 0.0507	Std 006 0.1961	Ctrl 006 0.2321	Un 006 0.2623	Pos 0.2927	Neg 0.3189						
G	Blk 0.0472	Std 007 0.1965	Ctrl 007 0.2327	Un 007 0.2652	Pos 0.2892	Neg 0.3228						
H	Blk 0.0487	Std 008 0.1944	Ctrl 008 0.2310	Un 008 0.2609	Pos 0.2853	Neg 0.3258						

Figure 5.4.01 Analysis Interface

Table 5 - 11 Legend: Data Analysis Interface

Name	Function
Raw Data	Click to display the algorithm that can be selected;
Data Source	Click to select the data source, the data source includes the raw data and blank subtraction data;

“Raw Data” is an item that cannot be deleted. The three modes of Endpoint, Kinetic and Spectrum have their own corresponding algorithm processes, and the algorithmic parameters cannot be deleted.

Users can execute the existing calculation method in the data analysis area to view the corresponding data/content in the main display area and the settings bar. For example, if the standard curve calculation method in the analysis interface is selected, the standard curve interface will be displayed, and the parameter settings of the standard curve will be displayed in the settings bar.

5.4.1 Endpoint Analysis

Endpoint calculations include blank subtraction, basic calculation, standard curve, quality control, classification.

Table 5 - 12 Restrictions: Endpoint Analysis

Name	Restriction condition
Blank Subtraction	Blank samples must be set to perform blank subtractions.
Standard Curve	The standard samples must be set in both the plate layout and in the set concentrations.
Quality Control	Quality control sample must be set up in the plate layout to analyze QC.
Classification	Negative and positive control samples must be set.

Table 5 - 13 Algorithm: Endpoint Calculations

Name	Algorithm
Blank Subtraction	<ul style="list-style-type: none"> - The read values of all blank wells in the sample group are averaged. - Subtract this average value from all samples within the group;
Basic Calculation	Data to data calculations <ul style="list-style-type: none"> - Select data as A. - Select one of the operators +, -, *, / between A and B. - Select data as B. - Get the calculation result.
Standard Curve	<ol style="list-style-type: none"> 1. Linear <ul style="list-style-type: none"> - The read values of the standard samples are linearly fitted by the least square method. 2. Linear (through the point of origin) <ul style="list-style-type: none"> - The read values of the standard samples are linearly fitted by the least square method and must pass through the point of origin. 3. Logistic (4PL) <ul style="list-style-type: none"> - Uses 4PL fitting to calculate.

	<p>4. Quadratic, Cubic, Quartic Polynomial</p> <ul style="list-style-type: none"> - Polynomial fitting calculation method, the core is the least square method. <p>5. Point to Point</p> <ul style="list-style-type: none"> - The data points are connected from point to point directly. <p>6. Cubic Spline</p> <ul style="list-style-type: none"> - Multiple linear system of equations. <p>7. Logit/log</p> <ul style="list-style-type: none"> - The core is the least square method.
Classification	<ul style="list-style-type: none"> - Select data source (concentration or absorbance). - Input values K_1, K_2, K_3. - The critical value is calculated according to the formula $K_1 \cdot NC + K_2 \cdot PC + K_3$ (where NC is the average value of negative sample reading, PC is the average value of positive sample reading). - Input values K_4. - According to the weak positive formula: $\pm K_4\%$ * critical value, to calculate the range of weak positive. - According to the positive formula: $>$ critical value, to calculate the positive range.
Quality Control	<ul style="list-style-type: none"> - Select data source (concentration or absorbance). - Set target value and deviation value. - Calculate the values of the upper and lower limits according to the target value and deviation, and then check whether the read data is within the range of the upper and lower limits. If so, it will be displayed.

5.4.2 Kinetic Analysis

Kinetic calculations include blank subtraction, basic calculation, and kinetic analysis.

Table 5 - 14 Restrictions: Kinetic Analysis

Name	Restriction condition
Blank Subtraction	Blank samples must be set to perform blank subtractions.
Kinetic Analysis	Kinetic readings must be performed prior to analysis.

Table 5 - 15 Algorithm: Kinetic Calculations

Name	Algorithm
Blank Subtraction	<ul style="list-style-type: none"> - The read value of all blank wells in the sample group are averaged. - Subtract this average value from all samples within the group.
Basic Calculation	<p>Data calculations:</p> <ul style="list-style-type: none"> - Select data as A. - Select one of the operators +, -, *, / between A and B. - Select data as B. - Get the calculation result.
Kinetic Analysis	<p>1. Average, SD, and CV</p> <ul style="list-style-type: none"> - Select the reading range and take the kinetic read data of

	<p>each wavelength.</p> <ul style="list-style-type: none"> - Get average, SD, and CV. <p>2. Integral to get the area of the curve</p> <ul style="list-style-type: none"> - Set reading range and take the kinetic read data of each wavelength. - Calculate the area of line segments according to the calculation method of trapezoidal area (if it is multiple line segments, disassemble to calculate). <p>3. Baseline subtraction. Select a baseline, all reading values minus the baseline value</p> <ul style="list-style-type: none"> - Select reading range and take the kinetic read data of each wavelength. - Set baseline points (from the beginning to a baseline point or from a baseline point to the end) to get a baseline. - Take the average of the baseline. - All the absorbances minus the average. <p>4. Maximum Rate</p> <ul style="list-style-type: none"> - Select readings range and take the kinetic read data of each wavelength. - Set the window value. - Set the units. - Calculate the reading difference between points (the reading at the last point minus the reading at the previous point) and divide by time. All results can be maximized according to the window partition. <p>5. Select Single Reading</p> <ul style="list-style-type: none"> - Set the readings, select a single reading. <p>6. Select Reading Range</p> <ul style="list-style-type: none"> - Set reading range and take the kinetic read data of each wavelength. <p>7. Maximum (Peak)</p> <ul style="list-style-type: none"> - The maximum value of each curve
--	--

5.4.3 Spectrum Analysis

Table 5 - 16 Restrictions: Spectrum Analysis

Name	Restriction condition
Blank Subtraction	Blank samples must be set to perform blank subtractions.
Spectral Analysis	Spectrum readings must be performed prior to spectral analysis. Must be in spectrum running mode

Table 5 - 17 Legend: Spectrum Calculations

Name	Algorithm
Blank Subtraction	<ul style="list-style-type: none"> - The readings of all blank well sin the sample group are averaged. - Subtract this average value from all samples within the group.
Basic Calculation	Data to data calculations <ul style="list-style-type: none"> - Select data as A.

	<ul style="list-style-type: none"> - Select one of the operators +, -, *, / between A and B. - Select data as B. - Get the calculation result.
Spectral Analysis	<ol style="list-style-type: none"> 1. Spectral Maximum (select spectrum range) <ul style="list-style-type: none"> - Select spectrum range. - Select threshold. - Find out the absorption peak with the maximum wavelength, which is greater than threshold. 2. Spectral Normalization(select spectrum range) <ul style="list-style-type: none"> - Set the spectral range, take the maximum absorption peak as the number 1, and the remaining values are converted into percentages based on this baseline. 3. Ratio within Spectrum <ul style="list-style-type: none"> - Set two wavelength values, λ_1 and λ_2, which can be selected in the spectral range. Take the value of λ_1/λ_2. 4. Select Wavelength Range <ul style="list-style-type: none"> - Set the start and end wavelengths and read the measurements in the wavelength range. 5. Select Single Wavelength <ul style="list-style-type: none"> - Set the wavelength value and read the measured value at that wavelength.

5.4.4 Standard Curve Analysis

Fig. 5.44.01; Standard curve parameters can be adjusted in the “Analysis” tab of the settings bar.

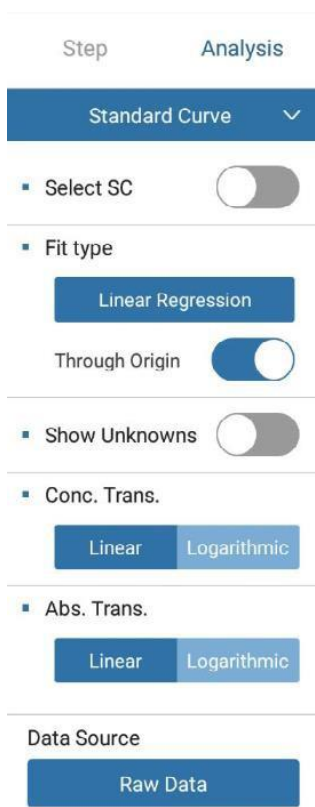

Figure 5.44.01 Standard Curve Settings
Table 5 - 18 Legend: Standard Curve Settings

Name	Function
Fit type	Select to designate a standard curve fitting (Fig. 5.7.01)
Show Unknowns	Select to display values of unknown samples on the standard curve.
Through origin	Select to view the generated standard curve as it passes through the point of origin.
Conc. Trans.	Transfer the concentration of the readings to a linear or logarithmic display.
Abs. Trans.	Transfer the absorbance of readings to a linear or logarithmic display.

Fig. 5.44.02 shows the interface for selecting a standard curve type. On this page, users can select the type of standard curve fits : linear regression, 4PL, quadratic polynomial, cubic polynomial, quartic polynomial, point to point, cubic spline, and logit/log.

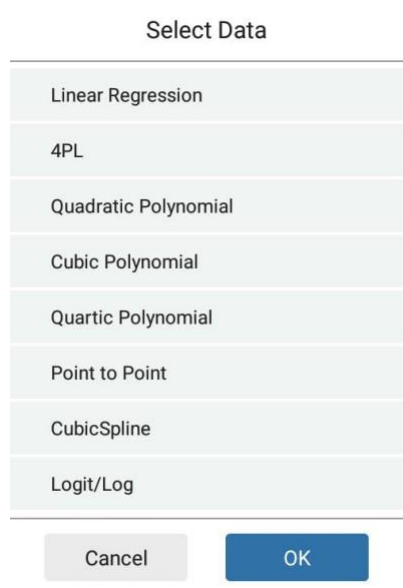





Figure 5.44.02 Standard Curve Settings: Fit Type

Table 5 - 19 Standard Curve Operations

Name	Function
	Select to save the generated standard curve to the library or to generate a QR code.
Saved to SC	Select to save the generated standard curve to the standard curve library
QR code	Select to save & view the generated standard curve as a QR code
	Select to view the running log

	Select to view the list of sample types in the current plate layout, along with values for measuring absorbance & concentrations for each wavelength measured.
	Select the wavelength used to perform the standard curve analysis

5.4.5 Kinetic Reading Analysis

For Kinetic readings, the following calculation parameters can be set/adjusted: average, integral, baseline subtraction, select single reading, select reading range, maximum rate, maximum (peak), & average rate.

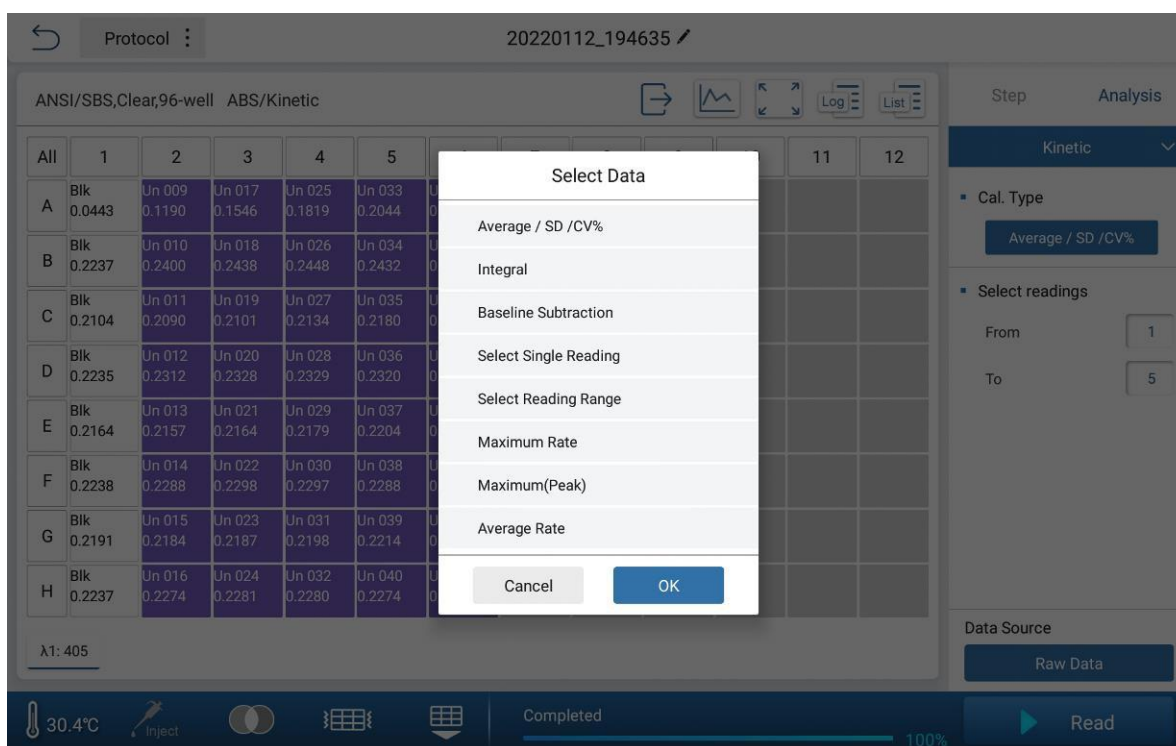

Figure 5.45.01 Kinetic Analysis: Data Source

5.4.6 Spectral Reading Analysis

For spectral readings, the following calculation parameters can be set/adjusted: spectral maximum, spectral normalization, ratio within spectrum, select wavelength range, and select single wavelength (Fig. 5.46.01).

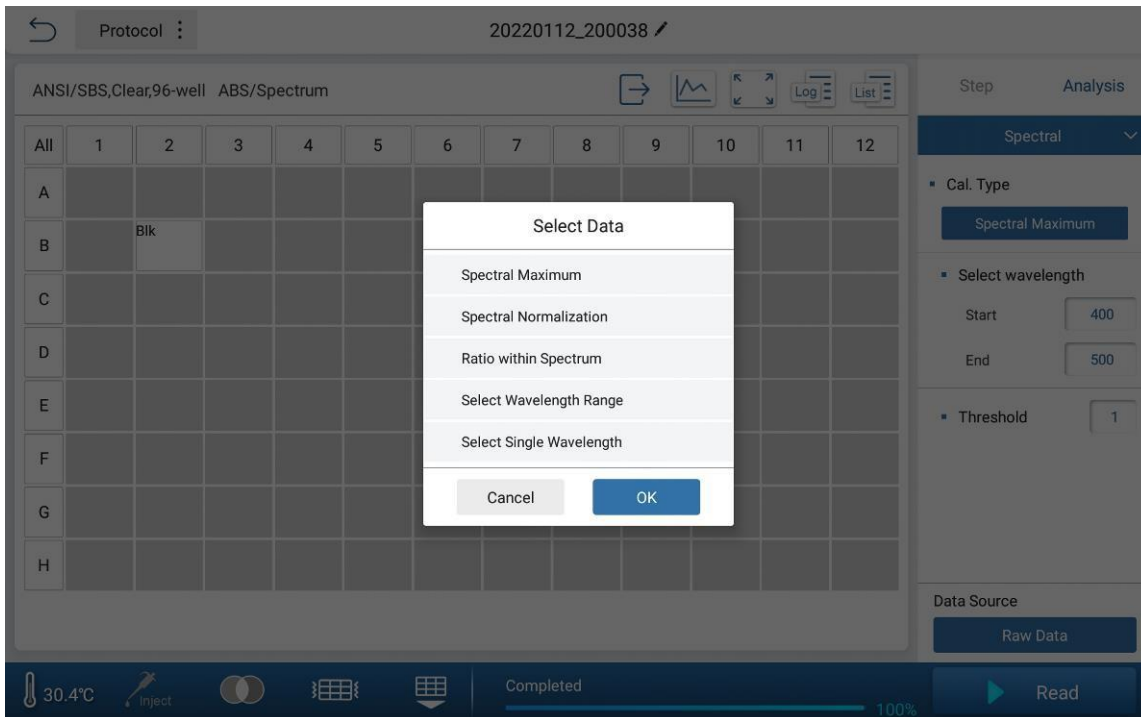

Figure 5.46.01 Spectral Analysis: Data Source

5.4.7 Multi-Wavelength Analysis

When basic calculation is selected, the following calculations can be set/adjusted: A+B, A-B, A*B, A/B (Fig. 5.47.01).

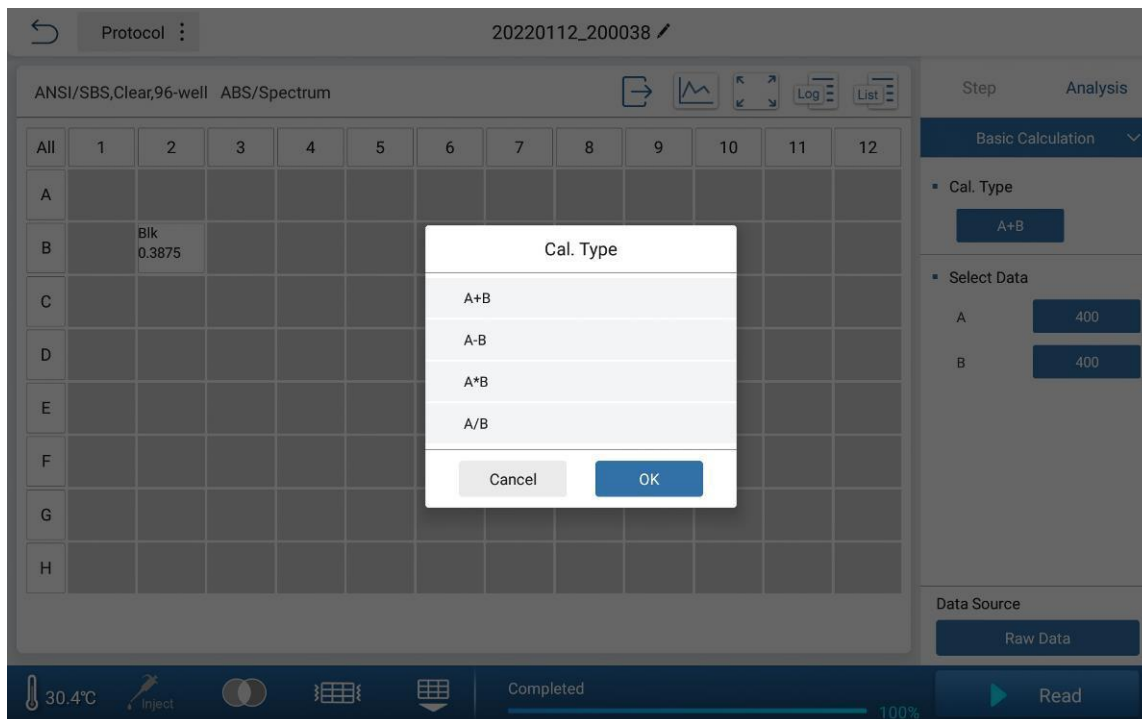

Figure 5.47.01 Multi-Wavelength Calculation Types

Fig. 5.47.02 shows the interface for selecting basic calculation data. The raw data and all calculated steps are displayed on the left, and all calculation options are displayed on the right.

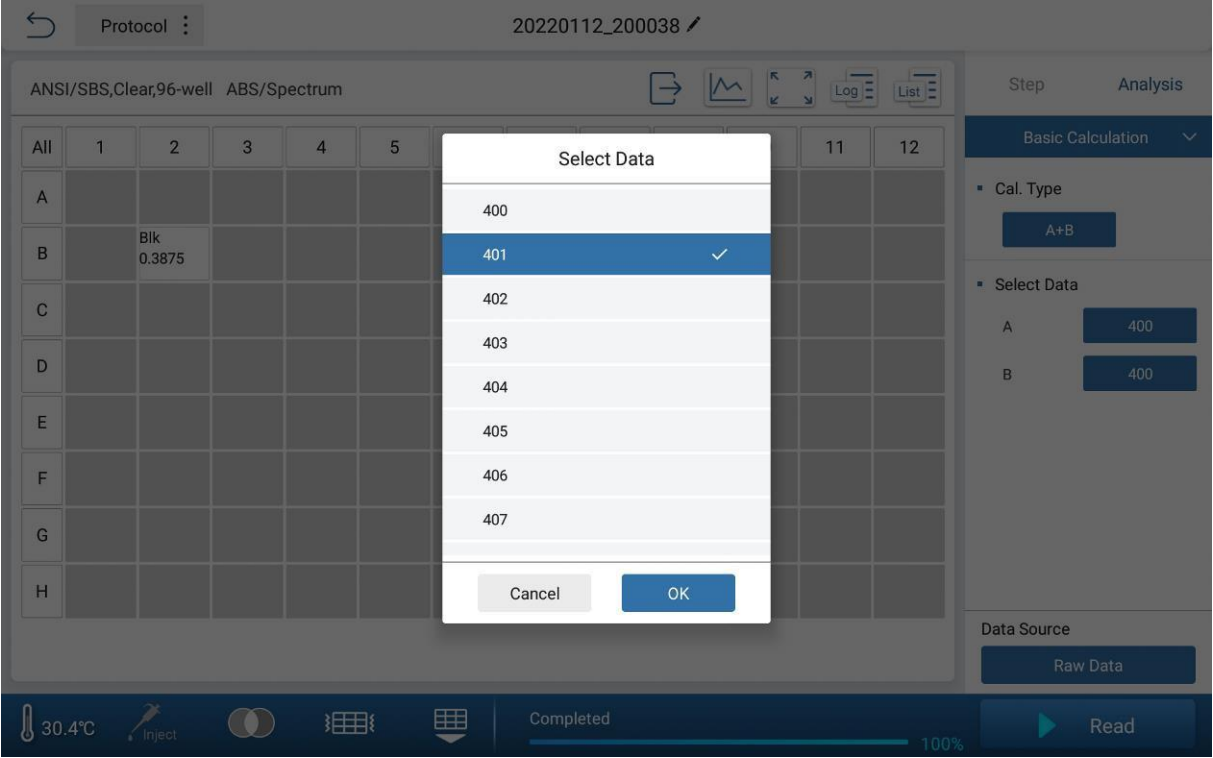

Figure 5.47.02 Multi-Wavelength Calculations: Select Data

5.4.8 Quality Control Analysis

After reading a plate, quality control calculations can be carried out in the “Analysis” tab found in the settings bar (Fig. 5.48.01).

The screenshot displays the software interface for quality control analysis. At the top, the protocol is identified as 'ANSI/SBS, Clear, 96-well ABS/Endpoint' with a sample ID of '20220112_194517'. The main data table lists 8 control samples (Ctrl 001 to Ctrl 008), each with a 'Passed' result. The right-hand panel is in the 'Analysis' step, showing 'Quality Control' settings where the 'Target' is set to 1.0 and 'SD' (Standard Deviation) is set to 0.5. A 'Data Source' section at the bottom right offers a 'Raw Data' option. The bottom status bar indicates the process is 'Completed' at 100% and includes a 'Read' button.

No.	Sample	Input	Value	Result
1	Ctrl 001	Target:1.0 SD:0.5	Coefficient:0.500 Upper:2.000 Lower:0.000	Passed
2	Ctrl 002	Target:1.0 SD:0.5	Coefficient:0.500 Upper:2.000 Lower:0.000	Passed
3	Ctrl 003	Target:1.0 SD:0.5	Coefficient:0.500 Upper:2.000 Lower:0.000	Passed
4	Ctrl 004	Target:1.0 SD:0.5	Coefficient:0.500 Upper:2.000 Lower:0.000	Passed
5	Ctrl 005	Target:1.0 SD:0.5	Coefficient:0.500 Upper:2.000 Lower:0.000	Passed
6	Ctrl 006	Target:1.0 SD:0.5	Coefficient:0.500 Upper:2.000 Lower:0.000	Passed
7	Ctrl 007	Target:1.0 SD:0.5	Coefficient:0.500 Upper:2.000 Lower:0.000	Passed
8	Ctrl 008	Target:1.0 SD:0.5	Coefficient:0.500 Upper:2.000 Lower:0.000	Passed

Figure 5.48.01 Quality Control Calculation Settings

Table 5 - 20 Legend: Quality Control Calculation Settings

Name	Function
Target	Target Value; Default = 1.000, range 0-999999, up to three decimal places;
SD	Standard Deviation; Default = 0.500, range 0-999999, up to three decimal places;
Add Rule	Select to add a rule. After a reading has been performed with the set rule(s), the instrument will determine whether each individual sample measurement conforms to the previously set rules.

5.4.9 Classification Analysis

Select “Classification” from the drop-down menu on the “Analysis” tab to view the “Classification Calculation Settings” (Fig. 5.49.01).



Figure 5.49.01 Classification Calculation Settings

Table 5 - 21 Legend: Classification Calculation Settings

Name	Function
Data Type	The value can be absorbance or concentration
K ₁	Click to enter K1 values, default 1, range 0-999999, Up to three decimal places.
K ₂	Click to enter K2 values, default 0, range 0-999999, Up to three decimal places.
K ₃	Click to enter K3 values, default 0, range 0-999999, Up to three decimal places.
K ₄	Click to enter K4 values, default 1, range 0-999999, Up to three decimal places.
Positive	Select the positive judgment sign.

In the main display area, the type will be displayed in the upper right corner of each data well in the display area. The positive icon is "++", the weak positive icon is "+", and the negative icon is "-", as shown in Figure 5.49.01.

5.5 SmartDrop™ Accessory Plate

The SmartDrop Plate is an optional accessory available for the SmartReader MultiMode. If the user has purchased the SmartDrop Accessory Plate, this function can be used for microvolume readings. Click the "SmartDrop Accessory Plate" button on the main menu interface to view the reading types available: users can select "Nucleic Acid", "Protein", or "UV-VIS" (**Fig. 5.80.01**).

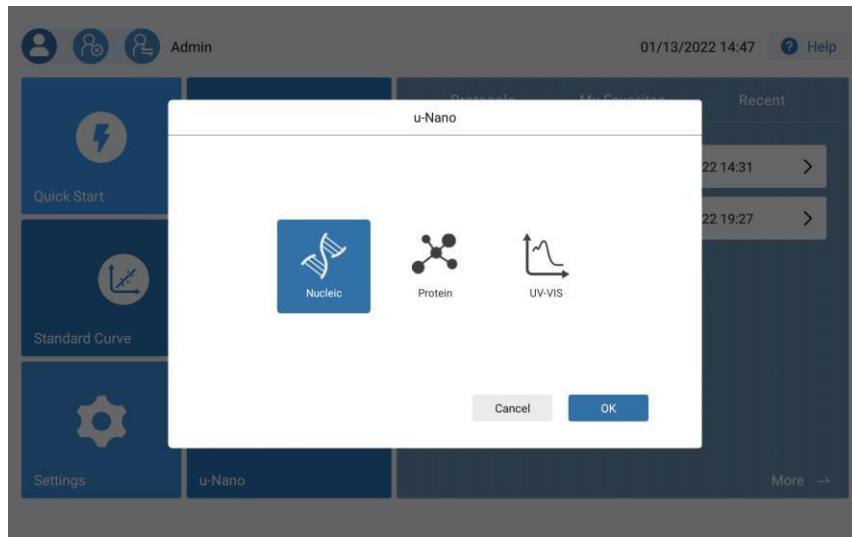

Fig. 5.5.01 Main Menu Interface: SmartDrop Accessory Plate

5.5.1 Nucleic Acid Interface

Select Nucleic Acid and click "OK" to enter the Nucleic Acid Interface. The main display area of the interface is shown in **Fig. 5.51.01** and **Fig. 5.51.02**. The plate layout can be found on the left of the display: rows (A-H) & columns (3-4).

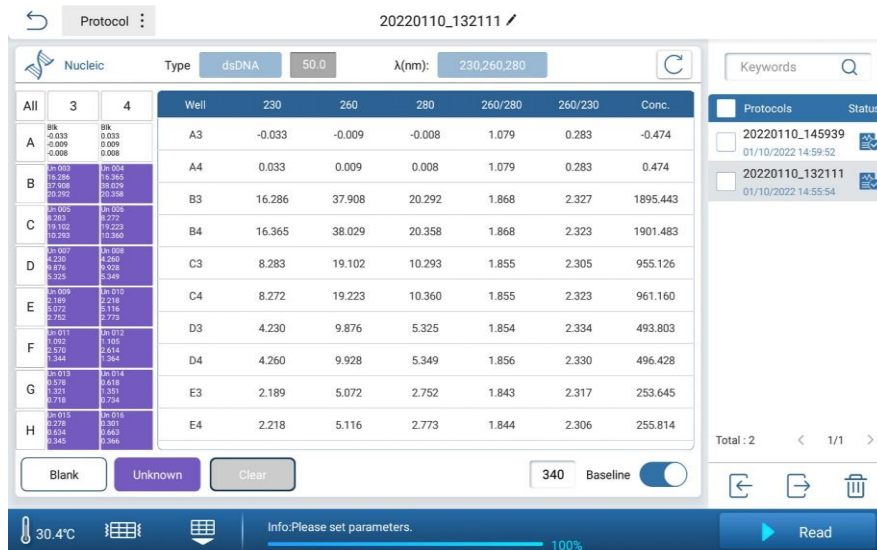

Figure 5.51.01 Main Menu Interface: Nucleic Acids (Fixed Wavelengths)

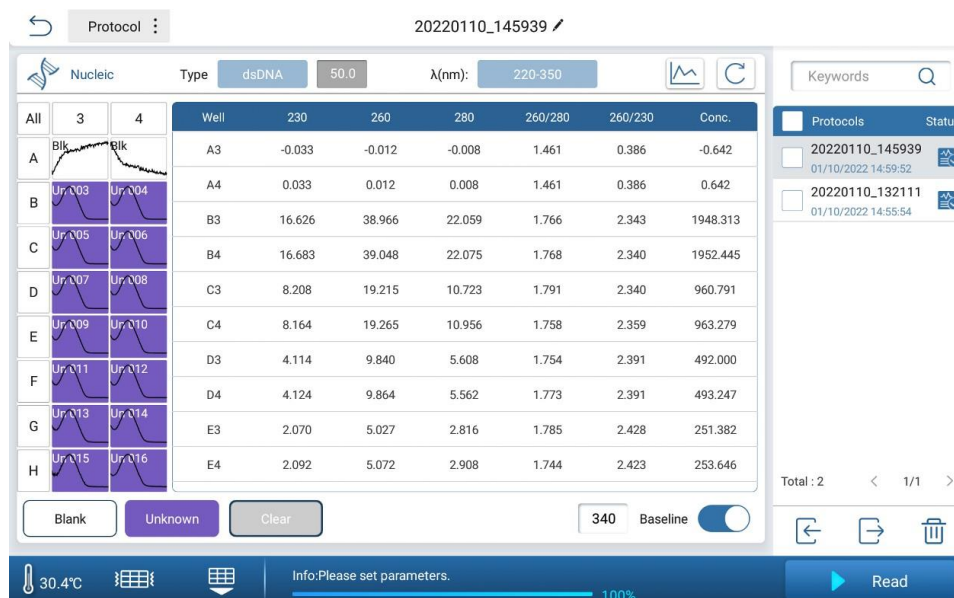



Figure 5.51.02 Main Menu Interface: Nucleic Acids (Spectral)

Table 5 - 22 Legend: Nucleic Acid Interface Operations

Name	Function
	Exit the Nucleic Acid Interface. A prompt will appear to ask if the current file should be saved prior to exiting. Select "Yes" to save the currently open file prior to exiting. Select "No" to exit the interface without saving the currently open file.
Protocol	Displays a selection box that allows the user to create a new protocol, save/save as the current protocol, export to a USB drive, export the protocol to a USB drive as a QR code, or export a report to a USB drive.
	Modify the currently set protocol name.
Upload	Upload the current protocol to the FTP. If the FTP upload feature is not enabled in the instrument settings, the button will not be available.
Type	Select the type of nucleic acid for measurement, including dsDNA, ssDNA, RNA, Others; The extinction coefficient of dsDNA is 50.0, ssDNA is 33.0, RNA is 40.0, the default value of Others is 25.0. Users can manually input the extinction coefficient from a range of 0.01-99.99;
λ (nm)	The reading mode can be selected from "multi-wavelength (230,260,280)" or "spectrum (220-350nm)";
	Click to view the graph of the selected well, (only available in spectrum mode)
	Click to refresh the current interface data;

Table 5 - 23 Legend: Nucleic Acid Interface Settings

Name	Function
Blank	Assign a blank to a well for measurement.
Unknown	Assign an unknown sample to a well for measurement.
Clear	Clear/Erase the currently set well .
Baseline	Can set whether to perform a baseline-correction from a range of 220-350nm.
Well	Display a list of the set wells.

When reading the spectrum of nucleic acids, select the well and click the curve icon () to display the spectral curve (**Fig. 5.51.03**).

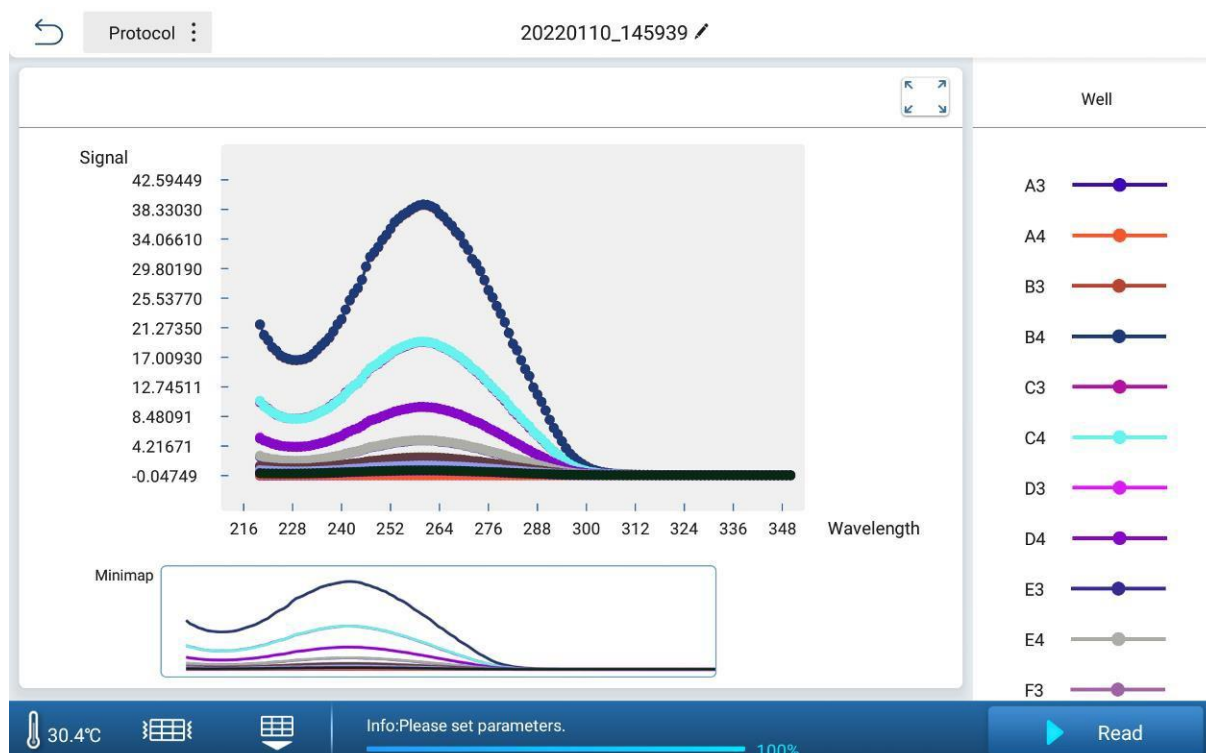





Figure 5.51.03 Nucleic Acid Spectral Curve Interface

Table 5 - 24 Legend: Nucleic Acid Menu Bar Settings

Name	Function
 27.5°C	In the SmartDrop Accessory Plate mode, the volume is small, so Incubation parameters are set off to safeguard against evaporation.
	Select to perform a temporal shake.
	Select to insert/retrieve the plate holder into/from the instrument.
 Read	Select to start a reading.

On the right of the nucleic acid interface is a list of all nucleic acid wells which include data for relevant wells. The executed icon is displayed next to the data, as shown in **Fig. 5.51.04**.



Figure 5.51.04 SmartDrop Accessory Plate Files Interface

Table 5 - 25 Legend: Files Settings

Name	Function
	Input-based search.
	Select the protocol for further operation.
	View File name and creation date.
	Shows whether the protocol has been executed. The icon with a check mark indicates a protocol has been executed and data has been generated.
Total : 16	Display the total number of saved protocols on the instrument.
	Previous page, current page / total pages, next page
	Import files into the instrument via USB. The imported files must be found in the directory as follows: The folder name of Proteins is Protein, and the folder name of UV-VIS is UV (Fig. 5.51.05).
	Export the current protocol to a USB drive (Fig. 5.51.06).



Delete a protocol. A system confirmation will be required to ensure protocol deletion.

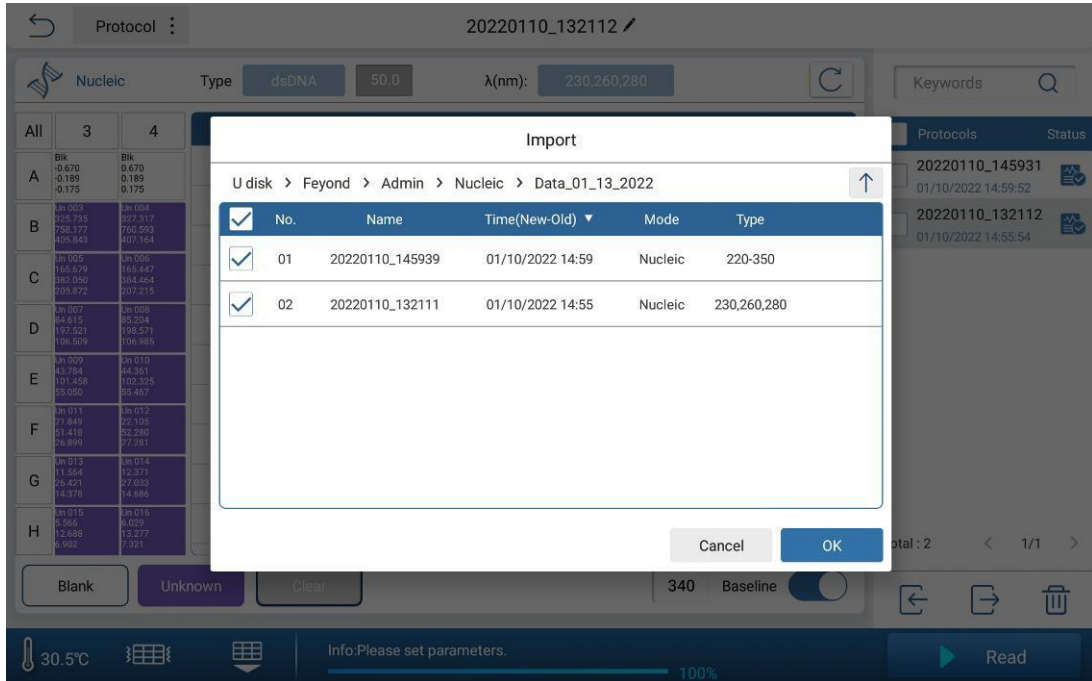

Figure 5.51.05 Protocol Import via USB

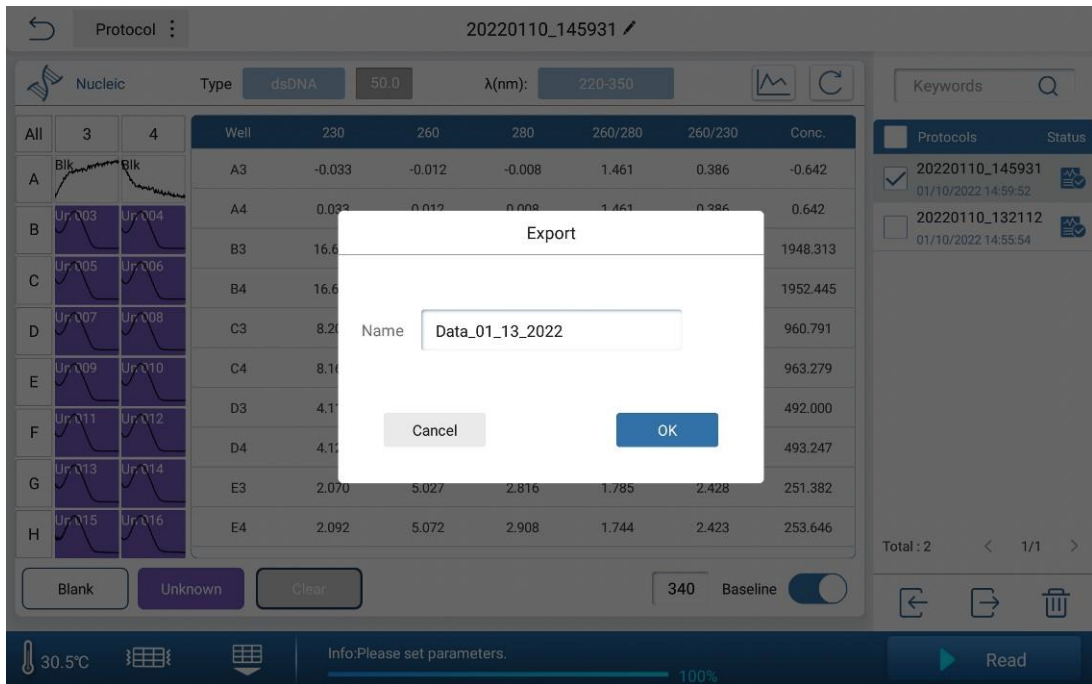

Figure 5.51.06 Protocol Export via USB

5.5.2 Proteins Interface

Select “Protein” and click “OK” to enter the Protein Interface. Users can select to read in multi-wavelength mode (260 & 280nm only; **Fig. 5.52.01**), or spectrum mode (220-350nm, 1nm step; **Fig 5.52.02**).



Figure 5.52.01 Main Menu Interface : Proteins (Fixed Wavelengths)



Figure 5. 52.02 Main Menu Interface : Proteins (Spectral)

Protein sample types include: A280, BSA, IgG, Lysozyme, & others. The coefficient of A280 is set to 10.0, BSA is 6.7, IgG is 13.7, Lysozyme is 26.4, and the default value of Others is 25.0. The coefficient can be manually adjusted from a range of 0.01-99.99.

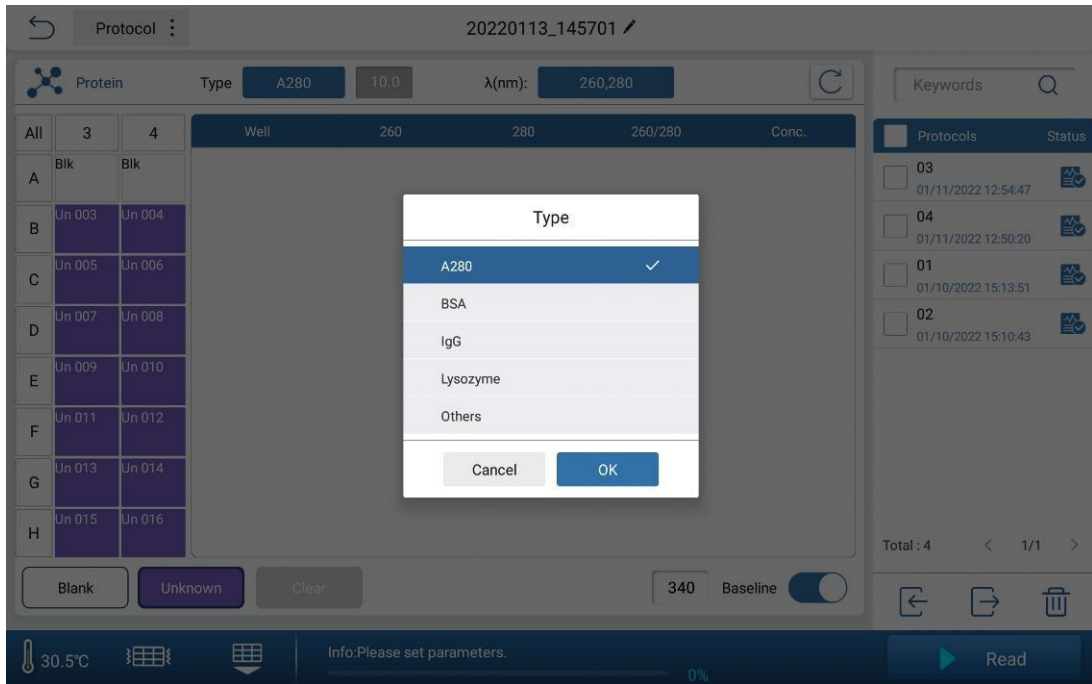

Figure 5.52.03 Protein Sample Types

5.5.3 UV-Vis Interface

Select UV-Vis and click “OK” to enter the UV-Vis Interface (Fig. 5.53.01). λ (nm): Set the starting wavelength, ending wavelength, and step. The default starting value is set to 200, and the default ending value is set to 350. The step value can be 1/5/10. The default value is set to 1. Baseline-correction can be toggled on/off, with the option to adjust the wavelength.

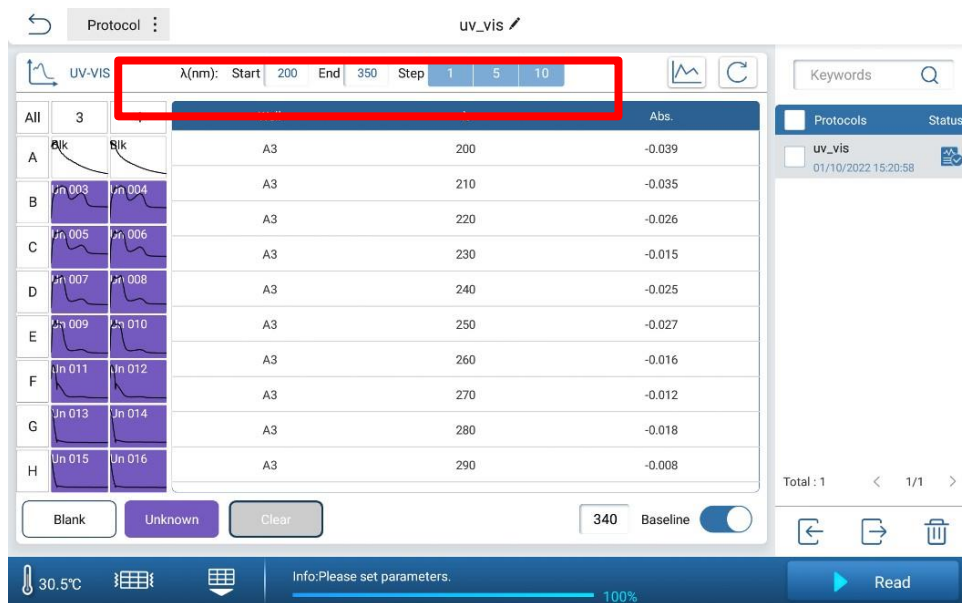

Figure 5.53.01 Main Menu Interface : UV-Vis

5.5.6 Data & Report Exporting

After the results have been processed, both the processed data and raw data can be exported in the Report interface. Click the "Protocol" button in the upper left corner, and then select "Report" to enter the "Data Export Interface" (**Fig. 5.56.01**).

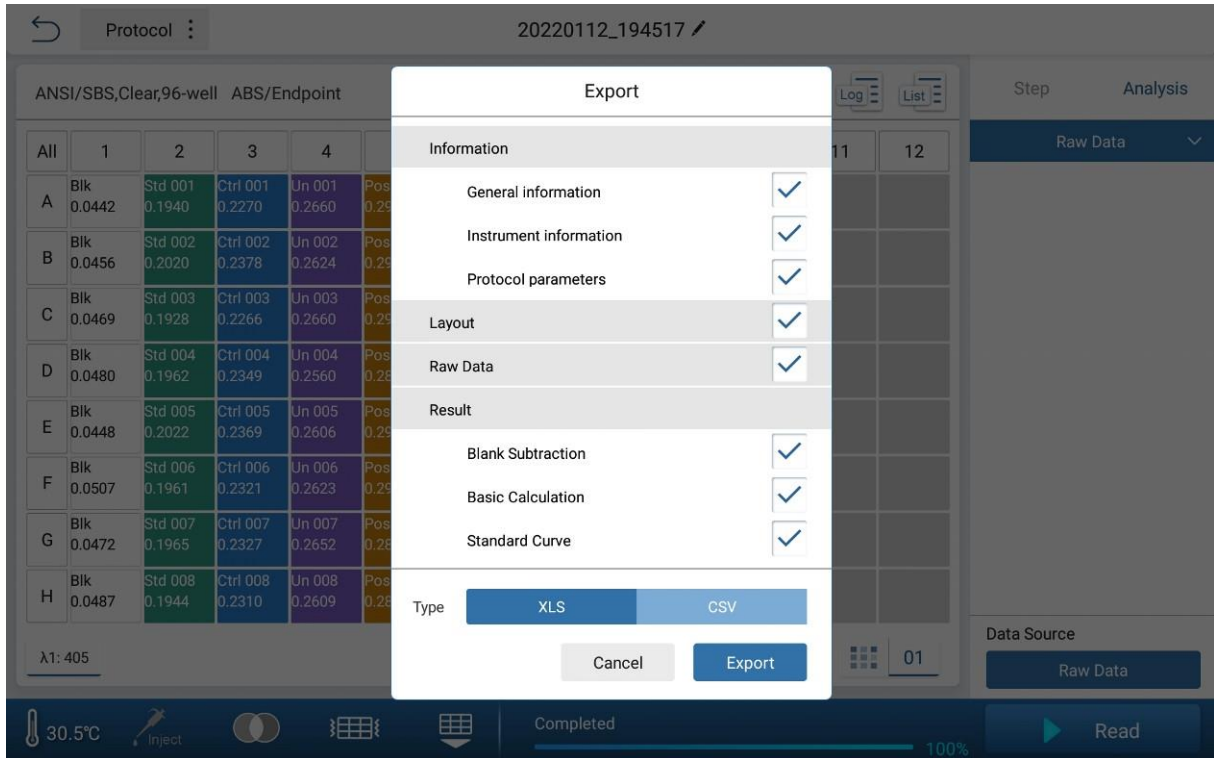

Figure. 5.56.01 Data Export Interface

Users can select which data to be included in the exported report by clicking on the checkmark “√” box. A √ indicates the respective data will be included in the exported report.

In the File Type row, users can select the report to be exported as the following file types:

- XLS
- CSV

Select "Export" to export the data to a USB drive.

Chapter 6 Troubleshooting

No.	Error	Analysis	Troubleshooting
1	The Microplate Reader does not power on	Power supply failure	Check the power plug .Check the voltage Contact Accuris Instruments
2	“Communication timeout” during self-check	Instrument Error	Restart the instrument and try again; if the problem persists, please contact Accuris Instruments.
3	“E913, E923, E933, E943” during self check	Insufficient light intensity	Contact Accuris Instruments.
4	“E912, E922, E932, E942” during self check	Light intensity is too strong	Contact Accuris Instruments.
5	“E911, E921, E931, E941” during self-check	Excessive dark current	Contact Accuris Instruments.
6	“E612, E622, E632, E642” during self-check	Detection module failure	Contact Accuris Instruments.
7	“E402, E403, E415, E425, E435, E445” during self check	Motor failure	Contact Accuris Instruments.
8	“E011~E056” during self check	Incubation Error	Contact Accuris Instruments.
9	Test results are greatly deviated, or are all zero	Xenon lamp damage	Restart the instrument and try again; if problem persists, contact Accuris Instruments.
10	Microplate holder unable to be inserted/retrieved	Physical obstruction present	Check whether obstacles are around the plate holder or whether the plate cover is elevated.
11	Crashing sound during operation	Microplate not inserted correctly. Microplate lid may have fallen off	Check microplate positioning If noise still there when performing a measurement without a plate, restart the instrument If the self-check is normal but the noise still persists, contact Accuris Instruments.
12	Test results unstable	Light path Error	Check if the plate is placed correctly, and if liquid spilled out. Check whether the plate holder is operating correctly. Restart the instrument. If the self-check is normal but the problem still persists, contact Accuris Instruments.
13	Instrument stops running during detection	Communication Error	Press “stop” and restart the measurement.